

**ZOOMLION**

# ZT26JE

# Operation and Safety Manual

Jul 2021 Version A



## **Foreword**

Zoomlion appreciates your choice of our machine for your application. The Operation and Safety Manual must be read and understood in its entirety before operating the machine.

This manual introduces you safety information, significant technical specs, safety operation in detail for working efficiency improving. Keep this manual properly at all times for looking up.

Do not operate the machine if there is any doubt in operation, please consult local service team for troubleshooting. Zoomlion Intelligent Access Machinery Co., Ltd. does not take the consequence of wrong operation.

This manual should be considered a permanent part of your machine and should remain with the machine at all times.

The content is under intellectual property protection, permission is required for a copy or other application.

There might be some tiny differences in details between your machine and the upgraded one due to the continuous improving. For clarification, questions, or additional information regarding any portions of this manual, contact local service team.

Our company reserves the right to modify this manual as technical improvement without notice.

Thank you for your trust and support for Zoomlion products!



## Safety Precaution Icons

This manual has the following safety precaution icons:



**Failure to comply with the safety precautions listed in this manual could result in personal injury or death.**



**Failure to comply with the safety precautions listed in this manual could result in potential personal injury or death.**



**Failure to comply with the safety precautions listed in this manual could result in potential mild personal injury.**



**Indicates risks unrelated with personal injury (such as property damage).**



## Contents

Foreword.....	I
Safety Precaution Icons.....	II
Contents .....	III
SECTION 1 SAFETY PRECAUTIONS .....	1-1
1.1 General.....	1-1
1.2 Pre-operation Caution .....	1-1
1.3 Hazard Classification .....	1-2
1.4 Intended Use .....	1-2
1.5 Safety Alert Symbols and Maintenance .....	1-2
1.6 Safety Operation .....	1-5
1.6.1 Operator safety.....	1-5
1.6.2 Workplace safety.....	1-5
SECTION 2 MACHINE COMPONENTS AND CONTROLS.....	2-1
2.1 Machine Components .....	2-1
2.2 Machine Controls and Indicators .....	2-1
2.2.1 Ground control console.....	2-1
2.2.2 Ground control indicator panel .....	2-4
2.2.3 Platform control console.....	2-5
2.2.4 Platform control indicator panel .....	2-9
Section 3 MACHINE INSPECTION.....	3-1
3.1 General.....	3-1
3.1.1 Pre-Start inspection principle.....	3-1
3.1.2 Pre-start inspection .....	3-1
3.2 Function Test.....	3-2
3.2.1 Function test principle .....	3-2
3.2.2 Ground function check.....	3-3
3.2.3 Platform function check.....	3-4
3.3 Workplace Inspection.....	3-7
3.3.1 Workplace inspection principle.....	3-7
3.3.2 Workplace inspection.....	3-7
3.4 Decal Inspection.....	3-9

## Contents

SECTION 4 OPERATION INSTRUCTION .....	4-1
4.1 General.....	4-1
4.2 Machine Operation.....	4-1
4.2.1 Drive operation .....	4-1
4.2.2 Platform leveling.....	4-3
4.2.3 Platform rotation.....	4-3
4.2.4 Turntable slewing.....	4-4
4.2.5 Raising and lowering the main boom .....	4-4
4.2.6 Telescoping the main boom .....	4-4
4.2.7 Raising and lowering the jib .....	4-4
4.2.8 Emergency stop.....	4-5
4.2.9 Auxiliary power .....	4-5
4.2.10 Shut down and park .....	4-5
4.2.11 Battery charging.....	4-6
4.3 Transport and Lifting .....	4-6
4.3.1 Release brake when towing .....	4-7
4.3.2 Lifting .....	4-7
4.3.3 Securing the chassis.....	4-7
4.3.4 Securing the platform.....	4-8
SECTION 5 MAINTENANCE .....	5-1
5.1 General.....	5-1
5.1.1 Maintenance symbols legend.....	5-1
5.1.2 Pre-start inspection .....	5-1
5.1.3 Maintenance hazards.....	5-2
5.1.4 Body injury hazard.....	5-2
5.2 Hydraulic System Maintenance .....	5-3
5.2.1 Check hydraulic oil.....	5-3
5.3 Battery Maintenance .....	5-5
5.4 Regular Maintenance .....	5-6
5.4.1 Swing drive.....	5-6
5.4.2 Hydraulic reservoir .....	5-7
5.4.3 Drive hub .....	5-8
5.5 Tire and Wheel.....	5-8
5.5.1 Tire replacement .....	5-8



## **Contents**

5.5.2 Wheel and tire replacement .....	5-9
5.5.3 Wheel installation .....	5-9
SECTION 6 STORAGE AND EX-FACTORY TEST .....	6-1
6.1 Storage Conditions.....	6-1
6.2 Ex-factory Test Items.....	6-1
SECTION 7 TECHNICAL PARAMETER.....	7-1



# **ZOOMLION**

**Operation and Safety Manual**

**Section 1 Safety Precautions**



## SECTION 1 SAFETY PRECAUTIONS

### 1.1 General

To Owners/Users/Operators:

Zoomlion appreciates your choice of our machine for your application. Our number one priority is user safety, which is best achieved by our joint efforts. The following requirements need to be adhere to for the purpose of safety operating.

- a) Obey all user rules, job site regulations and governmental regulations.
- b) Read, understand and obey all operating instructions on the machine and in this manual.
- c) Keep good safety operating conventions.
- d) Allow only those authorized and qualified personnel to operate the machine under the supervision of an experienced and qualified operator.
- e) An operator must not operate the machine if he has any doubts.

Zoomlion appreciates your choice of our machine for your application.

### 1.2 Pre-operation cautions



**Failure to comply with the safety precautions listed in this manual could result in personal injury or death.**

An operator must not operate the machine, only if:

- a) He has learned and practiced the principles of safe machine operation contained in this operational manual.
  - 1) Avoid hazardous situations.
  - 2) Be aware of safety rules before further operation.
  - 3) Perform a pre-operation inspection at all times.
  - 4) Implement functional test before operating the machine at all times.
  - 5) Inspect job site.
  - 6) Only use the machine as it was intended.
- b) Read, understand and obey the manufacturer's instructions and safety rules—safety and operator's manuals and machine decals.
- c) Read, understand and obey employer's safety rules and work site regulations.

- d) Read, understand and obey all applicable governmental regulations.
- e) The operator is properly trained to safely operate the machine.

### 1.3 Hazard Classification

Decals on this machine use symbols, color coding, and signal words to identify the following:



**Safety alert symbol-used to alert you to potential personal injury hazards. Obey all safety messages that follow this symbol to avoid possible injury or death.**



**Indicates a hazardous situation which, if not avoided, will result in death or serious injury. This decal will have a red background.**



**Indicates a hazardous situation which, if not avoided, could result in death or serious injury. This decal will have an orange background.**



**Indicates a hazardous situation which, if not avoided, could result in minor or moderate injury. This decal will have a yellow background.**



**Indicates a property damage message. This decal will have a blue background.**

### 1.4 Intended use

This machine is intended to be used only to lift personnel, along with their tools, and materials to an aerial work site.

### 1.5 Safety Alert Symbols and Maintenance

Replace any missing or damaged safety signs. Operator must keep safety awareness in mind at all times. Use mild soap and water to clean safety signs. Do not use solvent-based cleaners because they may damage the safety sign material.























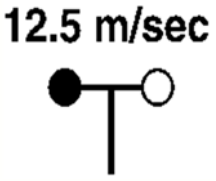

				
Read operational manual	Read service manual	Fire hazard	No smoking	Explosion hazard
				
Electrocution hazard	Burn hazard	Prohibit Step on	Avoid contact	Maintain required clearance
				
Electrocution hazard	Tip-over hazard	Tip-over hazard	Tip-over hazard	Tip-over hazard
				
Wheel load	Wind speed	Maximum capacity	Tie-down point	Lanyard anchorage points
				
Crushing hazard	Disconnect battery	Manual force	Collision hazard	Maintain safety distance

Figure 1-1 Symbol and Hazard Pictorials Definitions



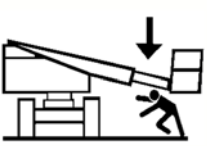

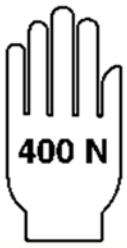





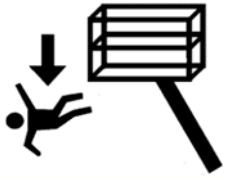



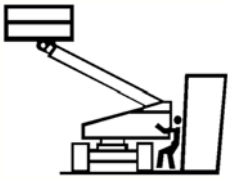

				
Runaway hazard	Fall hazards	Tire disassembly	Explosion hazard	No smoking. No flame Stop engine
				
Crushing hazard	Prohibit lifting	Lifting point	Avoid contact	Trained and authorized personnel operate the machine only
Recovery procedure if tilt alarm sounds while elevated				
				
Platform uphill: 1. Lower the main boom; 2. Retract the main boom.	Platform downhill: 1. Retract the main boom 2. Lower the main boom;	Prohibit high pressure water-beaktest	Prohibit modify the limit switches	Color coded direction arrows
				
Collision hazard	High temperature surface	Avoid contact	Fill fuel oil	Crushing hazard

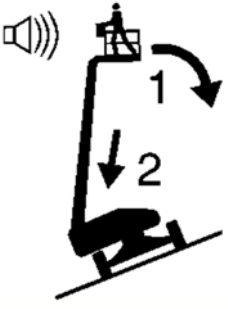
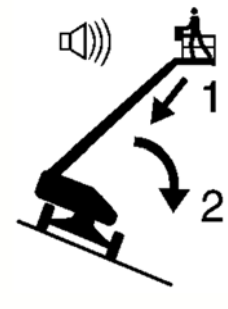
Figure 1-1 Symbol and Hazard Pictorials Definitions (continuous)



## 1.6 Safety Operation

### 1.6.1 Operator safety

#### Personal Fall Protection

Personal fall protection equipment (PFPE) is required when operating this machine. If PFPE is required in the workplace or in the rules of use, the following rules apply.

All PFPE must comply with applicable governmental regulations, and must be inspected and used in accordance with the PFPE manufacturer’s instructions.

### 1.6.2 Workplace safety



**This machine is not electrically insulated and will not provide protection from contact with or proximity to electrical current.**

- a) Obey all local and governmental regulations regarding required clearance from electrical power lines. At a minimum, the required clearance contained in the chart below must be followed.



**Table 1-1 Required Clearance**

No.	Line Voltage	Required Clearance
1	0 to 50KV	3.05 m/10ft
2	50 to 200KV	4.60 m /15ft1in
3	200 to 350KV	6.10 m/20ft
4	350 to 500KV	7.62 m/25ft
5	500 to 750KV	10.67m /35ft
6	750 to 1000KV	13.72m/45ft

- b) Allow for platform movement, electrical line sway or sag, and beware of strong or gusty winds.
- c) Keep away from the machine if it contacts energized power lines. Personnel on the ground or in the platform must not touch or operate the machine until energized power lines are shut off.



Do not operate the machine during lightning or storms.

Do not use the machine as a ground for welding.

**⚠ DANGER**

**Tip-over hazard**

**Occupants, equipment and materials shall not exceed the maximum platform capacity.**

**Table 1-2 Rated Load**

Maximum platform capacity Rated Load (unrestricted)	Maximum occupants	Maximum platform capacity Rated Load (restricted)	Maximum occupants
300 kg/660lb	2	454 kg/1000lb	3

- a) Do not exceed the maximum platform capacity.
- b) Do not attach a platform rated at 300 kg/660lb (unrestricted range of motion) or 454 kg/1000lb (restricted range of motion) to machines with any other rated load. See the serial label NO.35 for the maximum rated load.
- c) The weight in options and accessories (such as pipe, panel bracket and welder) will reduce rated platform capacity and must be factored into total platform load. See the decals with the options and accessories.
- d) If using accessories, read, understand and obey the decals and instructions with the accessory.
- e) Do not raise or extend the boom unless the machine is on a firm, level surface. Do not raise the platform or drive the machine with boom elevated when the machine is on a slope or uneven or soft ground.



Do not use the tilt alarm as a level indicator. The tilt alarm sounds in the platform only when the machine is on a severe slope.

If the tilt alarm sounds when the platform is raised, use extreme caution. Identify the condition of the boom on the slope as shown below. Follow the steps to lower the boom before moving to a firm, level surface. Do not rotate the boom while lowering.

a) If the tilt alarm sounds with the platform uphill:

- 1) Lower the main boom.
- 2) Retract the main boom.



b) If the tilt alarm sounds with the platform downhill:

- 1) Retract the main boom.
- 2) Lower the main boom.



Do not raise the boom when wind speeds may exceed 12.5 m/s (28mph).

If wind speeds exceed 12.5 m/s (28mph) when the boom is raised, lower the boom and do not continue to operate the machine. Do not operate the machine in strong or gusty winds. Do not increase the surface area of the platform or the load. Increasing the area exposed to the wind will decrease machine stability. Refer to Table 1-3 Beaufort's wind level (for reference only) or use other methods to monitor wind conditions.



**Table 1-3 Beaufort scale**

Beaufort scale	Wind speed (m/s)	Wind speed (mph)	Instruction
0	0.0-0.2	0.0-0.45	Calm
1	0.3-1.5	0.67-3.36	Light air
2	1.6-3.3	3.58-7.38	Light breeze
3	3.4-5.4	7.61-12.08	Gentle breeze
4	5.5-7.9	12.3-17.67	Moderate breeze
5	8.0-10.7	17.9-23.94	Fresh breeze
6	10.8-13.8	24.16-30.87	Strong breeze
7	13.9-17.1	31.09-38.25	Moderate gale
8	17.2-20.7	38.48-46.3	Fresh gale
9	20.8-24.4	46.53-54.58	Strong gale



- a) Be extreme careful and keep slow speeds while driving the machine in the stowed position across uneven terrain, debris, soft or slippery surfaces and near holes or drop-offs.
- b) Do not drive the machine on or near uneven terrain, unstable surfaces or other hazardous conditions with the boom raised or extended.
- c) Never attempt to use the machine as a crane.
- d) Do not push the machine or other objects with the boom.
- e) Do not hang up structural parts on the boom.
- f) Do not tie the boom or platform to adjacent structures.
- g) Do not place loads outside the platform perimeter.
- h) Do not alter or disable machine components that in any way affect safety and stability.
- i) Do not replace items critical to machine stability with items of different weight or specification.
- j) Do not replace factory-installed tires with tires of different specification or ply rating.
- k) These machines are equipped with foam-filled tires. Wheel weight is critical to stability.

- l) Do not use the platform controls to free a platform that is caught, snagged, or otherwise prevented from normal motion by an adjacent structure. All personnel must be removed from the platform before attempting to free the platform using the ground controls.
- m) Do not modify or alter an aerial work platform without prior written permission from the manufacture. Mounting attachments for holding tools or other materials onto the platform, toe boards, or guard rail system can increase the weight in the platform and the surface area of the platform or the load.
- n) Do not push off or pull toward any object outside of the platform.



**⚠ DANGER**

**Tip-over hazard**

**Manual force cannot be greater than specification when operating, otherwise may cause tipping over.**

**Table 1-4 Maximum allowable manual force**

Model	Manual force	Maximum occupants
ZT26JE	400 N/90lb	3

- a) Do not place or attach fixed or overhanging loads to any part of this machine.
- b) Do not place ladders or scaffolds in the platform or against any part of this machine.



- c) Do not transport tools and materials unless they are evenly distributed and can be safely handled by person(s) in the platform.
- d) Do not use the machine on a moving or mobile surface or vehicle.
- e) Be sure the tires are in good condition and the lug nuts tightened, besides the tightening torque should be 400N/m.
- f) Do not drive the machine on a slope that exceeds the maximum uphill, downhill or side slope rating of the machine. Slope rating applies only to machines in the stowed position.

**Table 1-5 Maximum slope rating, stowed position**

Maximum slope rating, stowed position	
Platform downhill	45% (24°)
Platform uphill	30% (17°)
Side slope	17% (10°)

Note: slope rating is subject to ground conditions with one person in the platform and adequate traction. Additional platform weight may reduce slope rating.



### Fall hazards

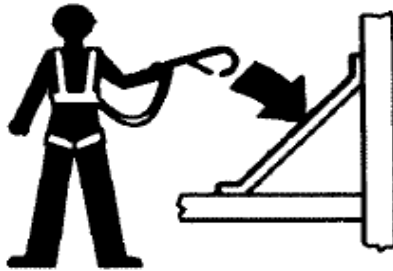

- a) Occupants must wear a safety belt or harness in accordance with governmental regulations. Attach the lanyard to the anchor provided in the platform.



- b) Do not sit, stand or climb on the platform guard rails. Maintain a firm footing on the platform floor at all times.



- c) Do not climb down from the platform when raised.
- d) Keep the platform floor clear of debris. Use extreme care while entering or exiting the platform. Do not enter or exit the platform unless the machine is in the stowed position. Enter or exit the platform through the gate only. Face the machine and ensure "three-point contact" with the machine (two hands and one foot, or two feet and one hand) while entering or exiting the platform.

**⚠ DANGER**

**Collision hazard**

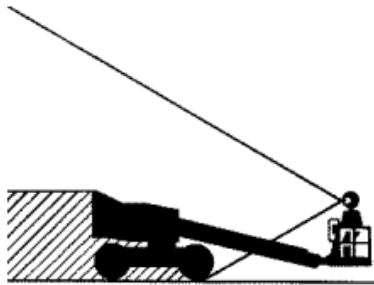

- a) Be aware of limited sight distance and blind spots when driving and operating.



- b) Check the work area for overhead obstructions or other possible hazards.



- c) Be aware of crushing hazards when grasping the platform guard rail.
- d) Be aware of the boom position and tail swing when rotating the turntable.
- e) Operators must comply with employer, job site, and governmental rules regarding use of personal protective equipment.

**⚠ DANGER**

**Do not lower the boom unless the area below is clear of personnel and obstructions.**



Limit travel speed according to the condition of the ground surface, congestion, slope, location of personnel, and any other factors which may cause collision.

Observe and use the color-coded direction arrows on the platform controls and drive chassis for drive and steer functions.

Do not operate the machine within the work range of any lifting units unless the controls of the units have been locked out and/or precautions have been taken to prevent any potential collision.



No stunt driving or horseplay while operating a machine.

**⚠ DANGER****Body Injury Hazard**

- a) Do not lower the boom unless the area below is clear of personnel and obstructions.
- b) Do not operate a machine with a hydraulic oil or air leak. An air leak or hydraulic leak can penetrate and/or burn skin.
- c) Improper service with components under hood will cause serious injury. Only trained maintenance personnel should access compartments.

Suggestion: Access by the operator is only advised when performing a pre-operation inspection. All covers must remain closed and secured during operation.

**⚠ DANGER****Explosion and Fire Hazards**

Do not charge the battery in hazardous locations where potentially flammable or explosive gases or particles may be present.

**⚠ DANGER****Damaged Machine Hazard**

- a) Do not use a damaged or malfunctioning machine. Conduct a thorough pre-operation inspection of the machine and test all functions before each work shift.
- b) Immediately tag and remove from service a damaged or malfunctioning machine.
- c) Be sure all maintenance has been performed as specified in this manual and the appropriate Zoomlion service manual.
- d) Be sure all decals are in place and legible.
- e) Be sure operational and maintenance manuals are complete, legible, and in the storage container located on the machine.

**⚠ DANGER****Component Damaged Hazard**

- a) Do not charge the battery with a charger greater than 12V.
- b) Do not use the machine as a ground for welding.
- c) Do not charge with unmatched power.

- d) Do not use the machine where there may be a strong magnetic field.

### Battery Safety



#### Burn hazard

- a) Batteries contain acid. Always wear protective clothing and eye wear when working with batteries.



- b) Avoid spilling or contacting battery acid. Neutralize battery acid spills with baking soda and water.  
c) Do not expose the battery or charger in water or rain while charging.



#### Explosion Hazard

- a) Keep sparks, flames, and lighted tobacco away from batteries. Batteries emit explosive gas.



- b) Do not use tools which could produce flames to contact battery terminals or cable clamp.



#### Electrocution Hazard

- a) Conduct daily check with wires and cables.  
b) Change damaged items prior to operation. Avoid contact with battery terminals. Remove all rings, watches and jewelry.



# **ZOOMLION**

**Operation and Safety Manual**

**Section 2 Machine Components  
and Controls**



## SECTION 2 MACHINE COMPONENTS AND CONTROLS

### 2.1 Machine Components

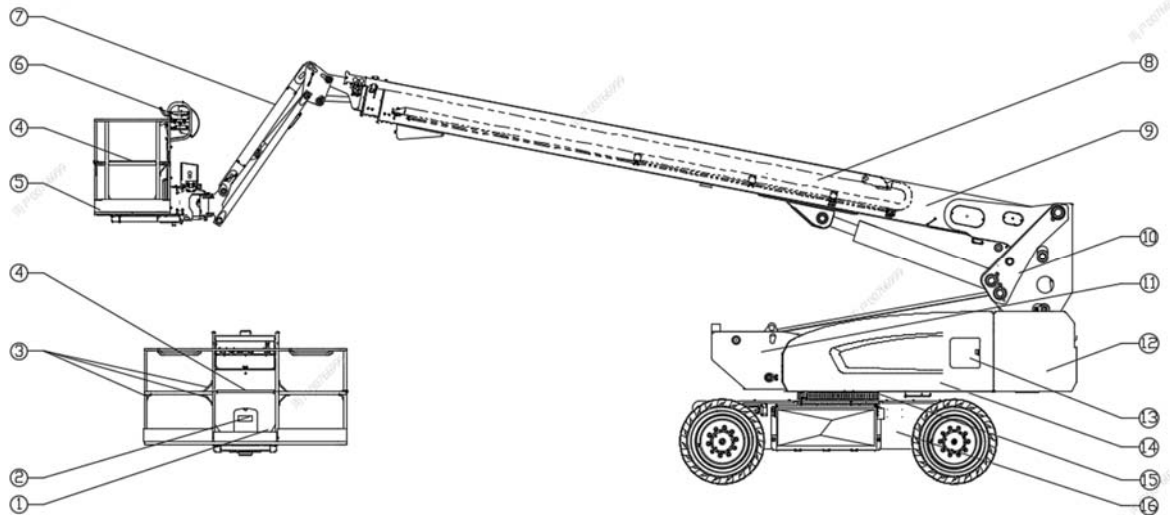

Figure 2-1 Components

Table 2-1 Component Instruction

No.	Item	No.	Item
1	Footswitch	9	Boom assembly
2	Manual storage container	10	Linkage
3	Lanyard anchorage points	11	Turntable assembly
4	Sliding rail	12	Counterweight assembly
5	Work platform assembly	13	Ground control console
6	Platform console	14	Hood assembly
7	Jib	15	Slew mechanism
8	Cable chain system	16	Chassis assembly

### 2.2 Machine controls and indicators

**⚠ CAUTION**

The manufacturer has no direct control over machine application and operation. The user and operator are responsible for conforming with good safety practices.

#### 2.2.1 Ground control console

**⚠ WARNING**

- a) Boom lift, boom extend/retract, turntable swing, jib lift, platform leveling, platform rotating device and auxiliary control device both equip with spring so that they will back to neutral when releasing.
- b) To avoid serious injury, do not operate machine if any control levers or toggle switches controlling platform movement do not return to the off position when released.
- c) Ensure there is no personnel under or surrounding the platform.

**⚠ CAUTION**

**Note:** Function Enable switch must be held down in order to operate main boom lift/telescope, turntable swing, jib lift, platform leveling, and platform rotate functions.



**Figure 2-2 Ground Control Panel**

**Table 2-2 Ground Control Panel Instruction**

No.	Item
1	Turntable rotation switch
2	Main boom lift switch
3	Main boom telescope switch
4	Display
5	Platform rotate switch
6	Platform leveling switch
7	Jib lift switch
8	Power/Emergency stop switch
9	Three position key control switch
10	Auxiliary power/Function enable switch

- 1) Turntable rotation switch

Provide 360° continuous rotating.



- 2) Main boom lift switch

Provides raising and lowering of the main boom.



- 3) Main boom telescope switch

Provide extension and retraction of the main boom.



- 4) Display

Reveal machine working condition, fault info, and machine info.



- 5) Platform rotate switch

Provide platform rotate controls.



**⚠ WARNING**

**Only use the platform leveling override function for slight leveling of the platform when platform is lowered. Incorrect use could cause the load/occupants to shift or fail. Failure to do so could result in death or serious injury.**

- 6) Platform leveling switch

Provide platform leveling controls. This switch is use to adjust platform level in situations.



- 7) Jib lift switch (if equipped)

Provide raising and lowering of the jib.

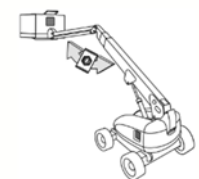

**⚠ CAUTION**

**When the machine is shut down, the power/emergency stop switch must be positioned to the Off position to prevent draining the batteries.**

8) Power/Emergency stop switch

Push in the red Power/Emergency Stop button to the off position to shut Platform/Ground power. Pull out the red Power/Emergency Stop button to the on position to power-up Platform/Ground Select Switch.



9) Platform/Ground Select Switch

Position the three key control switch to "Platform" (blue), platform mode works only. Position the three key control switch to "Ground" (red), ground mode works only. The three position, key operated switch positions to middle, platform mode and ground mode shut off at the same time.



**CAUTION**

To use auxiliary power, operate a single action only. (Compound operation is beyond the capability of auxiliary pump motor).

10) Auxiliary power/Function enable switch

If auxiliary power is needed, turn the switch to "UP" position to start the auxiliary pump and operate the machine after 2 seconds. The function of the auxiliary pump is to provide sufficient oil flow to power-up the basic functions in the event of a main pump or power system failure.



The switch must be held 'down' to enable all motion controls.

### 2.2.2 Ground Control Indicator Panel

The interface of display is as shown below:



Figure 2-3



The function classification is as shown below:

No.	Item
1	Status indicator
2	Chassis angle
3	Stowed position/Work position
4	Main boom angle/ Platform angle/ Main boom length
5	Cumulative working time
6	Main boom angle
7	Battery capacity

When system fails, press Fault Inquiry Button to enter fault info page:



### 2.2.3 Platform Control Console



**Avoid serious injury. Do not operate machine if any control levers or toggle switches controlling platform movement do not return to the off or neutral position when released.**

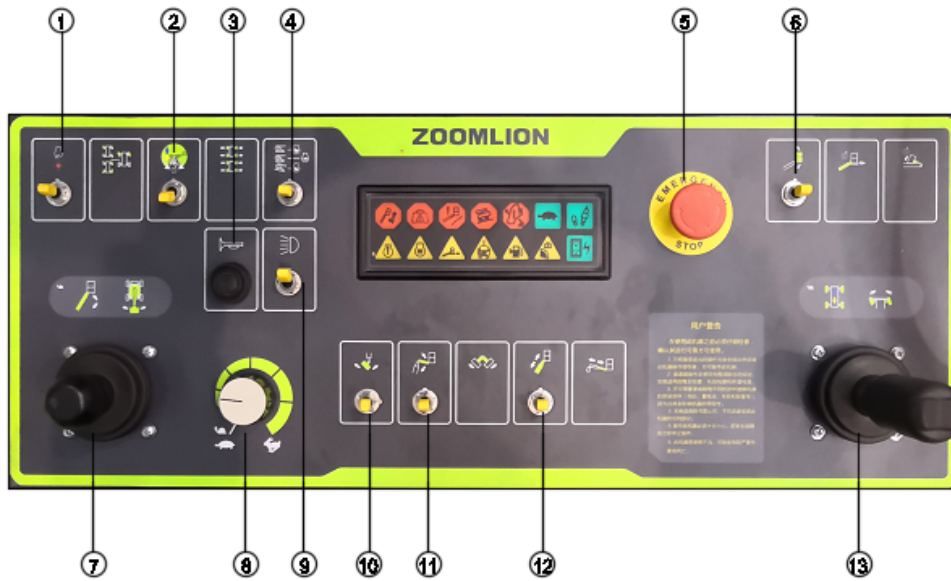

**Figure 2-12 Platform Control Panel**

(The switch number corresponding to the existing function has been identified.)

**Table 2-3 Platform control panel instruction**

No.	Item
1	Auxiliary power switch
2	Drive direction confirm switch
3	Horn switch
4	Drive select switch
5	Power/Emergency stop switch
6	Platform leveling switch
7	Main Lift/Swing Controller
8	Function speed control
9	Work light switch
10	Platform rotate switch
11	Jib lift switch
12	Main boom telescope switch
13	Drive/Steer controller

1) Auxiliary power switch

To use auxiliary power, turn the switch to "Down" to start auxiliary pump. The function of the auxiliary pump is to provide sufficient oil flow to power-up the basic functions in the event of a main pump or power system failure.



2) Drive direction confirm switch

When the boom is swung over the rear tires or further in either direction, the Drive Orientation indicator will illuminate when the drive function is selected. Push and release the switch, and within 3 seconds move the Drive/Steer control to activate drive and steer. Before driving, locate the blue/yellow orientation arrows on both the chassis and the platform controls. Move the drive controls in a direction matching the directional arrows.



3) Horn switch

Press horn switch, the horn sounds.



**Avoid serious injury, do not operate machine. If any control levers or toggle switches controlling platform movement do not return to the off or neutral position when released.**

4) Drive select switch

Turn the switch to "Up" position to reaching maximum drive speed;

Turn the switch to "Down" position reaching maximum torque for rough terrain and climbing grades.

The center position allows the machine to be driven in turtle speed.



5) Power/Emergency stop switch

Push in the red Power/Emergency Stop button to the off position to shut Platform power. Pull out the red Power/Emergency Stop button to the on position to power-up Platform.



**⚠ WARNING**

**Only use the platform leveling function for slight leveling of the platform. Incorrect use could cause the load/occupants to shift or fall. Failure to do so could result in serious injury.**

6) Platform leveling switch

Provide platform leveling controls. This switch is use to adjust platform level in situations.

Main Lift/Swing Controller.

Provides main boom lift and platform swing.

Push forward to lift the main boom, and pull backward to lower the main boom.

Move the handle to the left to swing clockwise, and move right to swing counterclockwise.

Note: depress the foot switch before lifting the main boom and swinging the turntable, then move the control handle. The handle is equipped with gas spring that the handle could return to neutral (off) position automatically when released.

7) Function speed control

This control could adjust the main boom telescoping speed.

Control the driving, turntable swinging and main boom lifting speed by function speed control to switch the speed between turtle and rabbit modes.

Turning the knob all the way counterclockwise until it clicks to put drive, main boom lift and swing into creep mode.

8) work light switch (if equipped)

This switch operates the chassis lights if machine is so equipped.

9) Platform rotate switch

Provide platform rotate controls.

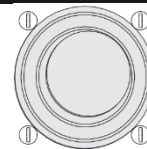
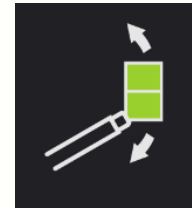

10) Jib lift switch

Provide raising and lowering of the jib.



11) Main boom telescope switch

Provide extension and retraction of the main boom.



12) Drive/Steer controller

Provides drive/steer controls.

Push forward to drive forward, and pull backward to drive backward.

Steering is accomplished via a thumb-activated rocker switch on the end of the steer handle.

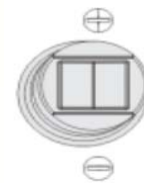

2.2.4 Platform Control Indicator Panel

Note: the indicator lights will illuminate for approximately 1 second when the key is positioned to the on position to act as a self-test.



Figure 2-13 Platform Control Indicator Panel

Table 2-4 Platform Indicator Panel Instruction

No.	Item
1	Leveling system fault indicator
2	Platform overload indicator
3	Wire rope loosen indicator
4	Tilt Alarm Warning Light
5	Main boom system fault indicator
6	Creep Speed Indicator
7	System fault indicator
8	Axle fully extending indicator

9	Soft touch indicator
10	Drive direction confirm indicator
11	Limited position indicator
12	Footswitch indicator
13	Battery capacity indicator

### **WARNING**

**If leveling system fault indicator lights up, shut off the machine and restart. If fault occurs again, retract the platform to stowed position via manual leveling function, and service the leveling system.**

1) Leveling system fault indicator

Indicates faults in electronic leveling system. Indicator will flash, and alarm will sound. If boom is lifting, creep mode is automatically activated. If leveling system fault indicator lights up, shut off the machine and restart. If fault occurs again, retract the platform to stowed position via manual leveling function, and service the leveling system.



2) Platform overload indicator

Indicates the platform has been overloaded.



3) Wire rope loosen indicator

Indicates loosen or damage of main boom wire rope, service or adjust it immediately.



4) Tilt Alarm Warning Light

This illuminator indicates that the chassis is on a slope.

An alarm will also sound when the chassis is on an excessive slope (over 5°).

If tilt alarm sounds in stowed position, creep mode is automatically activated.

If tilt alarm sounds, drive, steer and telescope functions will be disabled, and other motions will be limited to creep mode.



### **WARNING**

**a) If the tilt alarm sounds with the platform uphill:**

**proceed as follows:**

- i. Lower the main boom.



ii. Retract the main boom.

**b) If the tilt alarm sounds with the platform downhill:**

**proceed as follows:**

- i. Retract the main boom.
- ii. Lower the main boom.



5) Main boom system fault indicator

Indicates that the length of main boom cannot measure, need check boom length sensor.



6) Creep mode indicator

When the Function Speed Control is turned to the creep position, the indicator acts as a reminder that all functions are set to slowest speed. The light will be on continuously if the operator selects creep speed.



**⚠ WARNING**

**To avoid serious injury, do not remove, modify or disable the foot switch by blocking or any other means. Foot switch must be adjusted if malfunctions occur.**

7) System fault indicator

Indicates system faults.



8) Axle fully extending indicator



9) Soft touch indicator

Indicate that soft touch function activates.



10) Drive direction confirm indicator

When the boom is swung over the rear tires or further in either direction, the Drive Orientation indicator will illuminate when the drive function is selected.



This is a signal for the operator to verify that the drive control is being operated in the proper

direction (to verify if the machine drive in reversed direction).

11) Limited position indicator

Indicate limited position of boom.



12) Footswitch indicator

To operate any function, the footswitch must be depressed and the function selected with 7 seconds.

The enable indicator shows that the controls are enabled.

If a function is not selected within seven seconds, or if a seven second lapse between ending on function and beginning the next function, the enable light will go out and the foot switch must be released and depressed again to enable the controls. Releasing the foot switch stops all platform controls.



13) Battery capacity indicator

.Indicate the remaining capacity of 25%, 50%, 75% or 100%.



# ZOOMLION

Operation and Safety Manual

Section 3 Machine Inspection



## SECTION 3 MACHINE INSPECTION

### 3.1 General



**An operator must not operate the machine, only if:**

**He has learned and practiced the principles of safe machine operation contained in this operational manual.**

- a) Only use the machine as it was intended.
- b) Know and understand the pre-operation inspection before going on to the next section.
- c) Implement functional test before operating the machine at all times.
- d) Inspect job site.
- e) Only use the machine as it was intended.

#### 3.1.1 Pre-Start Inspection Principle

- a) It is the responsibility of the operator to perform a pre-operation inspection and routine maintenance.
- b) The pre-operation inspection is a visual inspection performed by the operator prior to each work shift. The inspection is designed to discover if anything is apparently wrong with a machine before the operator performs the function tests.
- c) The pre-operation inspection also serves to determine if routine maintenance procedures are required. Only routine maintenance items specified in this manual may be performed by the operator.
- d) Refer to the list on the next page and check each of the items.
- e) If damage or any unauthorized variation from factory delivered condition is discovered, the machine must be tagged and removed from service.
- f) Repairs to the machine may only be made by a qualified service technician, according to the manufacturer's specifications. After repairs are completed, the operator must perform a pre-operation inspection again before going on to the function tests.
- g) Scheduled maintenance inspections shall be performed by qualified service technicians, according to the manufacturer's specifications and the requirements listed in the responsibilities manual.

#### 3.1.2 Pre-Start Inspection

- a) Be sure operator's, safety, and responsibilities manuals are complete, legible, and in the storage container located on the machine.
- b) Be sure all decals are in place and legible. See Inspections section.

- c) Check for hydraulic oil leaks and proper oil level. Add oil if needed. See Maintenance section.
- d) Check the following components or areas for damage, improperly installed, or missing parts and unauthorized modifications:
  - 1) Electrical components, wiring, and electrical cables.
  - 2) Hydraulic hoses, fittings, cylinders, and manifolds.
  - 3) Fuel and hydraulic tanks.
  - 4) drive gear.
  - 5) Wear pads.
  - 6) Tires and wheels.
  - 7) Engine and related components.
  - 8) Limited switch and horn.
  - 9) Alarm and indicator (if equipped).
  - 10) Nuts, bolts and other fasteners.
  - 11) Platform entry mid-rail or gate.
  - 12) Platform load cell.
  - 13) Lanyard anchorage points.
  - 14) Check entire machine for:
    - i. Cracks in welds or structural components.
    - ii. Dents or damage to machine.
    - iii. Excessive rust, corrosion or oxidation.
- e) Be sure that all structural and other critical components are present and all associated fasteners and pins are in place and properly tightened.
- f) Be sure that batteries properly connect;
- g) After you complete your inspection, be sure that all covers are in place and latched.
- h) Note: be sure that the jib is in proper place when raising the platform for maintenance. See Operating Instruction section.

## 3.2 Function Test

### 3.2.1 Function test principle

- a) The function tests are designed to discover any malfunctions before the machine is put into service. The operator must follow the step-by-step instructions to test all machine functions.

- b) A malfunctioning machine must never be used. If malfunctions are discovered, the machine must be tagged and removed from service. Repairs to the machine may only be made by a qualified service technician, according to the manufacturer's specifications.
- c) After repairs are completed, the operator must perform a pre-operation inspection again before putting the machine into service.



**An operator must not operate the machine, only if:**

**He has learned and practiced the principles of safe machine operation contained in this operational manual.**

- a) Avoid hazardous situations.
- b) Perform a pre-operation inspection at all times.
- c) Implement functional test before operating the machine at all times.
- d) Inspect job site.
- e) Only use the machine as it was intended.

### **3.2.2 Ground function check**

- a) Test emergency stop:
  - 1) Select a test area that is firm, level and free of obstruction.
  - 2) Turn the key switch to ground control (red).
  - 3) Pull out the red Power/Emergency Stop button to the on position.  
Check test result: ground display powers up.
  - 4) Push in the red Power/Emergency Stop button to the off position.  
Check test result: the engine should shut off and no functions should operate.
- b) Test machine functions:
  - 1) In ground control mode, pull out the red Power/Emergency Stop button to the ON position;
  - 2) Do not operate the Function Enable Button;
  - 3) Attempt to activate each boom and platform function button;  
Check test result: No boom and platform functions should operate;
  - 4) In ground control mode, pull out the red Power/Emergency Stop button to the ON position;
  - 5) Push and hold the Function Enable Button and maintain the enabled state;

- 6) Attempt to activate each function button.

Check test result: All functions should operate when function enable switch activated.

- c) Test Auxiliary Power:

- 1) In ground control mode, pull out the red Power/Emergency Stop button to the ON position;
- 2) Operate auxiliary power switch;
- 3) Attempt to activate each function button.

Check test result: All boom and platform functions should operate at the auxiliary power mode.

Note: Do not recommend to use auxiliary power for a long time if the machine could run normally as long time usage of auxiliary power could shorten the service life of auxiliary pump and battery.

### 3.2.3 Platform function check

- a) Test emergency stop:

- 1) Select a test area that is firm, level and free of obstruction.
- 2) Turn the key switch to platform control (blue).
- 3) Pull out the red platform Power/Emergency Stop button to the on position.

Check test result: Platform alarm panel powers on.

- 4) Push in the red Power/Emergency Stop button to the off position.

Check test result: Platform alarm panel should shut off and no functions should operate.

- b) Test the foot switch:

- 1) In platform control mode, pull out the red Power/Emergency Stop button to the ON position;
- 2) Do not press down the foot switch;
- 3) Attempt to activate each boom and platform function button;

Check test result: No boom and platform functions should operate;

- 4) In platform control mode, pull out the red Power/Emergency Stop button to the ON position;
- 5) Press down the foot switch and activate each boom and platform function button;
- 6) Attempt to activate each function button.

Check test result: All boom and platform functions should operate when foot switch activated.

- c) Test Auxiliary Power:

- 1) In platform control mode, pull out the red Power/Emergency Stop button to the ON position;

- 2) Operate auxiliary power switch;
- 3) Press down the foot switch and activate each boom and platform function button;
- 4) Attempt to activate each boom and platform function button;

Check test result: All boom and platform functions except driving and steering should operate at the auxiliary power mode.

d) Test Horn:

- 1) Press the horn button at the platform controls.

Check test result: the horn should sound.

e) Test the Steering

- 1) In platform control mode, pull out the red Power/Emergency Stop button to the ON position;
- 2) Press down the foot switch and activate each boom and platform function button;
- 3) Move the steering handle;
- 4) Release the steering handle.



Check test result: The wheels should turn in the direction that the control handle operates. Release the steering handle, the steering function is disabled.

f) Test Drive and Braking

- 1) In platform control mode, pull out the red Power/Emergency Stop button to the ON position;
- 2) Press down the foot switch and activate each boom and platform function button;
- 3) Move the drive control handle.
- 4) Release the drive control handle.

Check test result: The machine should turn in the direction that the control handle operates. Release the drive handle, the drive function is disabled.

g) Test the Drive Enable System

- 1) In platform control mode, pull out the red Power/Emergency Stop button to the ON position;
- 2) Press down the foot switch and activate each boom and platform function button.
- 3) Rotate the turntable until the main boom moves past a circle-end wheel.
- 4) Attempt to operate drive handle.

Check test result: the drive enable indicator light should light up while the main boom is anywhere outside of the range shown. The drive function should not operate.

- 5) Move the drive enable toggle switch.
- 6) Attempt to operate drive handle.

Check test result: move the drive enable toggle switch and drive in low speed.

### h) Test Limited Drive Speed

- 1) In platform control mode, pull out the red Power/Emergency Stop button to the ON position;
- 2) Press down the foot switch and activate each boom and platform function button.
- 3) Lift the main boom up to about  $7^\circ$  above horizontal.
- 4) Attempt to operate drive handle.

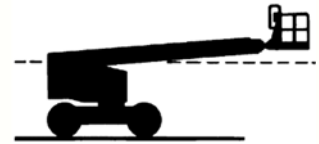

Check test result: the drive speed should switch to creep speed with the main boom raised.

- 5) Lower the main boom to stowed position.
- 6) Extend the main boom by 1 meter/3.28ft.
- 7) Attempt to operate drive handle.

Check test result: the drive speed should switch to creep speed with the main boom extended.

- 8) Lower the main boom to stowed position.
- 9) Attempt to operate drive handle.

Check test result: the drive speed should switch to high speed with the main boom retracted to stowed position.

Note: the angle between the boom and the horizontal ground is less than  $7^\circ$ , the extension length is less than 1 meter.

### i) Test drive tilt protection.

- 1) Press down the foot switch and activate each boom and platform function button.
- 2) Drive the machine till the chassis angle reaches  $5^\circ$  when the main boom is fully retracted (forward to backward).

Check test result: all actions are unrestricted, all motion speeds are limited to creep speed, and the platform alarm sounds an alarm.

- 3) Move the machine to the ground and extend the main boom approximately 1 meter/3.28ft or more.
- 4) Drive the machine till the chassis angle reaches  $5^\circ$  (forward to backward).

Check test result: when the machine reaches a  $5^\circ$  chassis tilt, the machine is prohibited from



walking and turning, and the platform alarm gives an alarm.

- 5) Retract the main boom to the stowed position.

Check test result: the machine could drive.

- 6) Move the machine to the ground and raise the main boom to a height that is greater than 7° from the horizontal level.

- 7) Drive the machine till the chassis angle reaches 5° from the horizontal ground (forward to backward).

Check test result: when the machine reaches a 5° chassis tilt, the machine is prohibited from walking and turning, and the platform alarm gives an alarm.

- 8) Retract the main boom to the stowed position.

Check test result: the machine could drive.

### 3.3 Workplace Inspection



**An operator must not operate the machine, only if:**

**He has learned and practiced the principles of safe machine operation contained in this operational manual.**

- a) Avoid hazardous situations.
- b) Perform a pre-operation inspection at all times.
- c) Implement functional test before operating the machine at all times.
- d) Inspect job site.

Know and understand the workplace inspection before going on to the next section.

Only use the machine as it was intended.

#### 3.3.1 Workplace inspection principle

The workplace inspection helps the operator determine if the workplace is suitable for safe machine operation. It should be performed by the operator prior to moving the machine to the workplace.

It is the operator's responsibility to read and remember the workplace hazards, then watch for and avoid them while moving, setting up, and operating the machine.

#### 3.3.2 Workplace inspection

Be aware of and avoid the following hazardous situations:

- a) Drop-offs or holes.

- b) bumps, floor obstructions, or debris.
- c) Sloped surfaces.
- d) Unstable or slippery surfaces.
- e) Overhead obstructions and high voltage conductors.
- f) Hazardous locations.
- g) Inadequate surface support to withstand all load forces imposed by the machine.
- h) Wind and weather conditions.
- i) the presence of unauthorized personnel.
- j) Other possible unsafe condition.

### 3.4 Decal Inspection

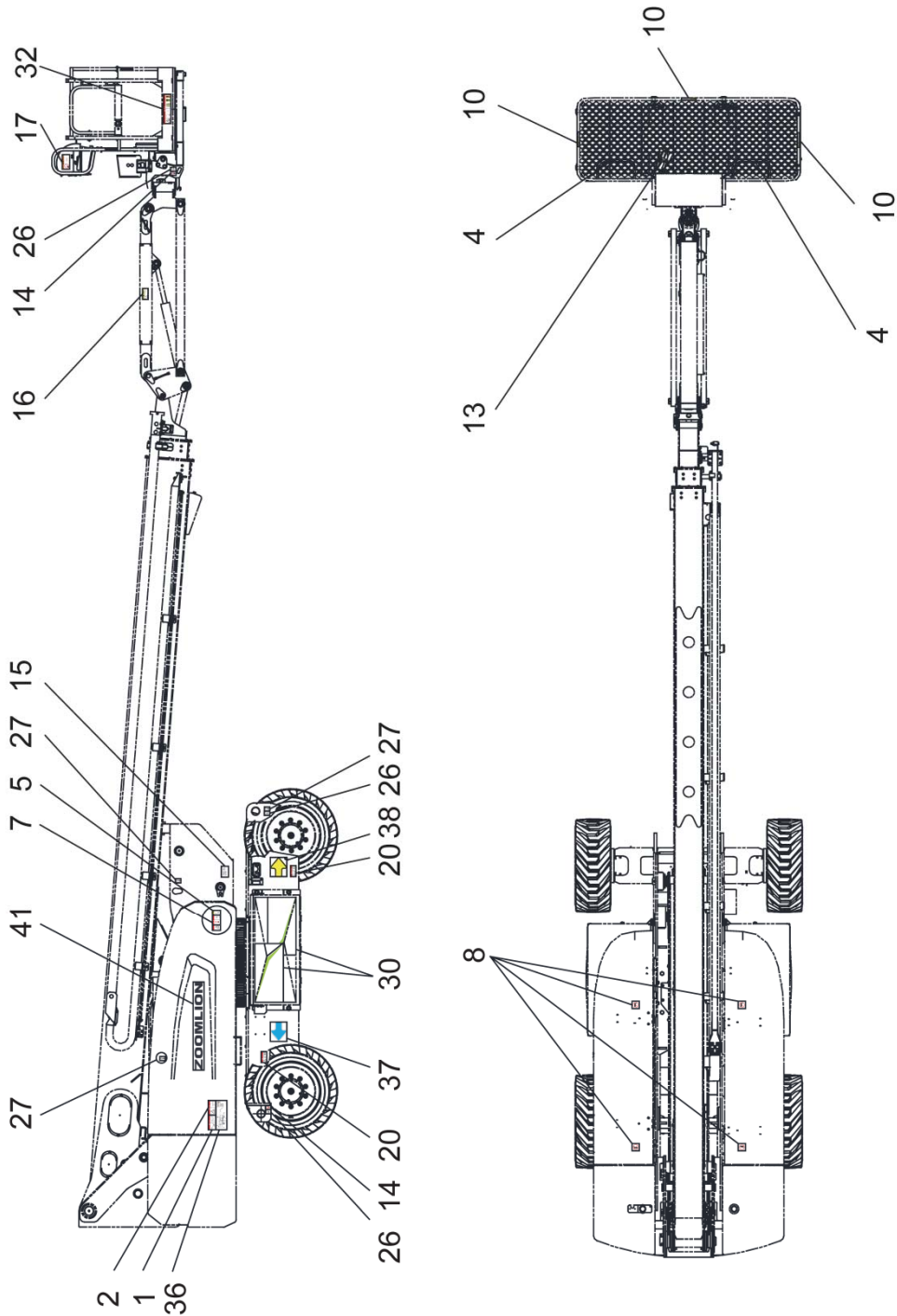

Figure 3-1 Decal Position



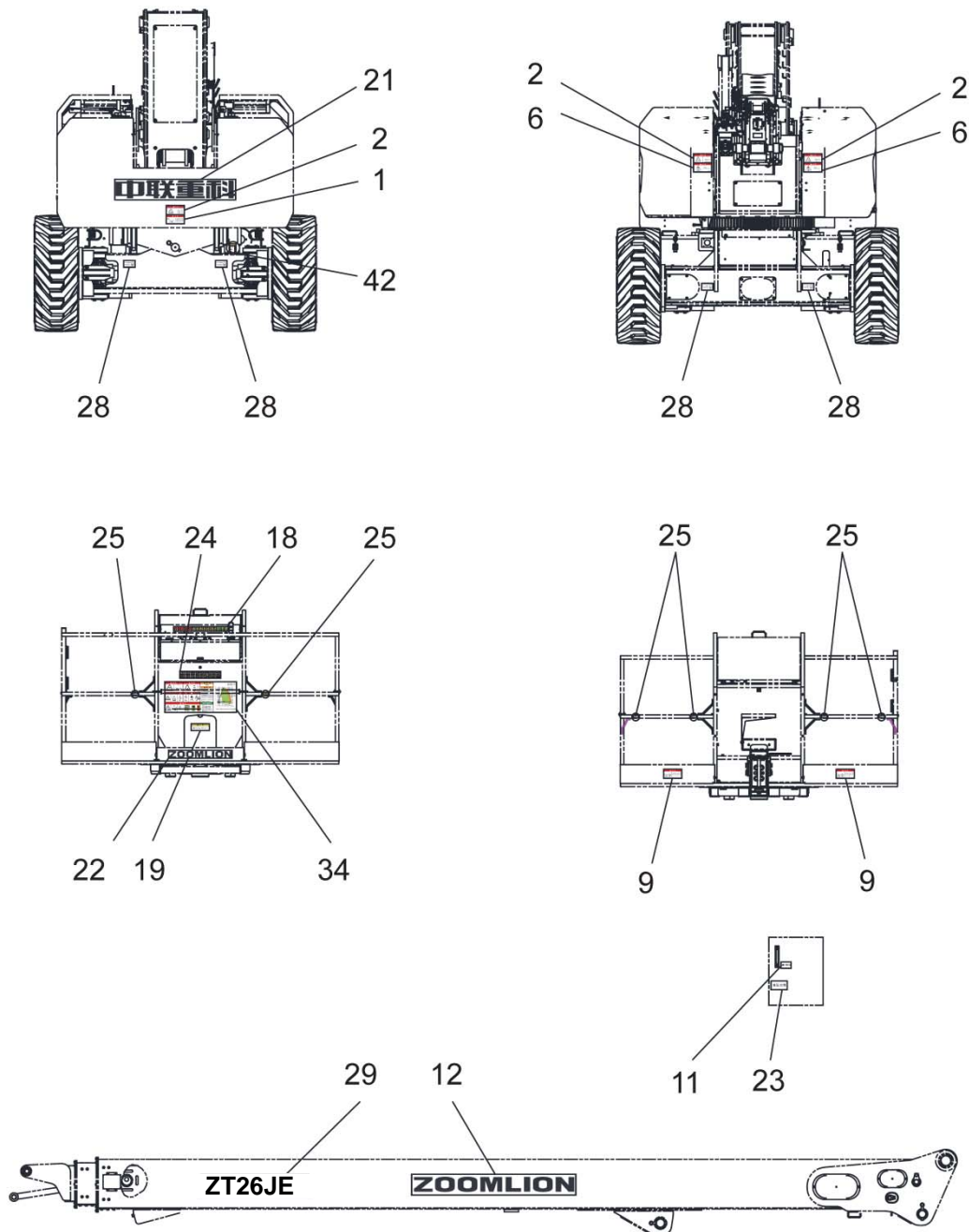

Figure 3-1 Decal Position (continuous)

Use the pictures on next page to verify that all decals are legible and in place.







Below is a numerical list with quantities and descriptions.

Table 3-1 Decals



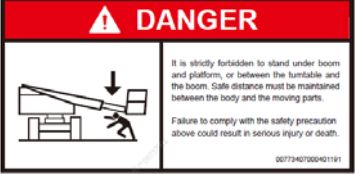
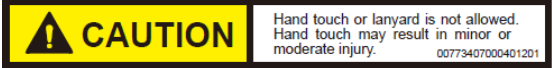



Numbers are corresponded to the decal (not all decal are pasted on the machine)

No.	Part No.	Qty	Decal
1	00773407000201211	2	
	Crushing hazard		
2	00773407000201071	4	
	Electrocution hazard		
3	00773407000201081	1	
	Ground Indicator		
4	00773407010201031	2	
	Handrail position		
5	00773407000201151	3	
	Disconnect battery		
6	00773407000201321	2	
	Collision hazard		

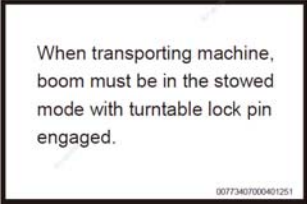
Table 3-1 Decals (continuous)

No.	Part No.	Qty	Decal
7	00773407000201381	3	
	Explosion Hazard		
8	00773407000201181	6	
	Prohibit Step on		
9	00773407000201191	2	
	Crushing hazard		
10	00773407000201201	3	
	Caution - No hands or lanyards		
11	00773407000201481	1	
	Decal- Low Oil Level		
12	00771407000201130	1	
	ZOOMLION LOGO on boom		
13	00773407000201231	1	
	Hazard- pedal failure		

**Table 3-1 Decals (continuous)**

No.	Part No.	Qty	Decal
14	00773407000201241	4	
	Prohibit lifting		
15	00773407000201251	1	
	Plug stop pin		
16	00773407010201021	2	
	Risk of Pinching Hand		
17	00773407000201271	4	
	No flushing		
18	00773407000201221	1	
	Platform indicator		
19	00773407000201391	1	
	Keep the manual with the machine at all times		
20	00773407000201561	4	
	Overturning hazard - tire		



**Table 3-1 Decals (continuous)**





21	00773407000201050	1	<b>ZOOMLION</b>
	ZOOMLION LOGO on counterweight		
22	00773407000201010	1	<b>ZOOMLION</b>
	ZOOMLION LOGO on platform		
23	00771407000201161	1	
	Hydraulic tank		
24	00773407000201141	1	
	Label- Platform Console Instruction		
25	00773407000201411	6	
	Lanyard point		
26	00773407000201421	6	
	Tie-down position		
27	00773407000201431	6	
	Hoisting point		

Table 3-1 Decals (continuous)





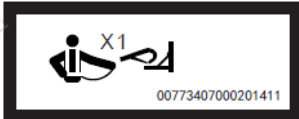

No.	Part No.	Qty	Decal
28	00771407000201021	4	
	Wheel load		
29	00771407030201010	1	
	Model type on boom - ZT26JE		
30	00771407030201020	2	
	Label - flash I		
31	00771407030201030	2	
	Label - flash II		
32	00771407030201040	2	
	Overturning hazard		
33	00771407030201050	1	
	ZT26JE Turntable label assembly		

Table 3-1 Decals (continuous)

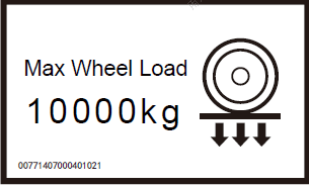
No.	Part No.	Qty	Decal										
34	00771407030201060	1											
	ZT26JE Platform label assembly												
36	00771407030201080	1	<table border="1" style="float: right; margin-top: 10px;"> <thead> <tr> <th colspan="2">GG</th> </tr> </thead> <tbody> <tr> <td>A</td> <td>903 mm</td> </tr> <tr> <td>B</td> <td>2236 mm</td> </tr> <tr> <td>C</td> <td>1091 mm</td> </tr> <tr> <td>D</td> <td>1350 mm</td> </tr> </tbody> </table>	GG		A	903 mm	B	2236 mm	C	1091 mm	D	1350 mm
	GG												
A	903 mm												
B	2236 mm												
C	1091 mm												
D	1350 mm												
	Label- Transport and Lift Instruction												
37	00771407000201080	3											
	Label- Blue arrow												
38	00771407000201090	3											
	Label- Yellow arrow												
39	00771407000201100	2											
	Label- Yellow triangle												
40	00771407000201110	2											
	Label- Blue triangle												
41	00771407000201120	2											
	ZOOMLION LOGO												

Table 3-1 Decals (continuous)

No.	Part No.	Qty	Decal
42	00773407010201441	1	
	Main power switch		
43	00773409910201042	1	
	Nameplate		

# **ZOOMLION**

**Operation and Safety Manual**

**Section 4 Operation Instruction**



## SECTION 4 OPERATION INSTRUCTION

### 4.1 General



**An operator must not operate the machine, only if:**

**He has learned and practiced the principles of safe machine operation contained in this operational manual.**

- a) Avoid hazardous situations.
- b) Perform a pre-operation inspection at all times.
- c) Implement functional test before operating the machine at all times.
- d) Inspect job site.
- e) Only use the machine as it was intended.

Fundamentals:

The Operating Instructions section provides instructions for each aspect of machine operation. It is the operator's responsibility to follow all the safety rules and instructions in the operator's, safety and responsibilities manuals.

Using the machine for anything other than lifting personnel, along with their tools and materials, to an aerial work site is unsafe and dangerous.

Only trained and authorized personnel should be permitted to operate a machine. If more than one operator is expected to use a machine at different times in the same work shift, they must all be qualified operators and are all expected to follow all safety rules and instructions in the operator's, safety and responsibilities manuals. That means every new operator should perform a pre-operation inspection, function tests, and a workplace inspection before using the machine.

### 4.2 Machine Operation

#### 4.2.1 Drive Operation

Traveling is limited by two factors:

- a) Gradeability, which is the percent of grade of the incline the machine can climb.
- b) Side slope, which is angle of the slope the machine can be driven across.



Max slope rating, platform uphill (gradeability):  
4WD: 45% (24°)



Max slope rating, platform downhill (gradeability):  
4WD: 30% (17°)



Max side slope rating:  
4WD: 17% (10°)

Note: Identify the allowable range of slope and side slope rating. All ratings for Gradeability and Sideslope are based upon the machine's main boom being in the stowed position, fully lowered and retracted.



**Note:**

- a) Do not drive with main boom out of transport mode except on a smooth, firm and level surface.
- b) To avoid loss of travel control or upset on grades and side slopes, do not drive machine on grades or side slopes exceeding those specified on machine nameplate.
- c) Chassis angle should not exceed 5° when working, and less than 24° when stowed.
- d) Confirm the control of driving direction before operation.
- e) Be extremely careful when driving in reverse or platform raising.

### 4.2.1.1 Traveling Forward and Reverse

- a) At Platform Controls, pull out Emergency Stop switch, start the engine, and activate footswitch.
- b) Position DRIVE/STEER control to “FORWARD” OR “REVERSE” hold for duration of forward or reverse travel desired.



Note: the machine is equipped with travelling direction indicator lights. This indicator on the platform control box lights up to indicate that the main boom has exceeded the position between the two non-steer wheels and the drive function has been turned off.





If the indicator is illuminated, operate the Drive function in the following manner:

- a) Check blue and yellow arrow on platform control panel and on chassis match or not, confirm the travelling direction.
- b) Toggle and loosen travelling direction confirmation switch. Operate the handle to drive as needed within 7 seconds.



#### 4.2.1.2 Steering

- a) At Platform Controls, pull out Emergency Stop switch, start the engine, and activate footswitch.
- b) As needed, press the button on the top of the driving / steering handle to the left to operate the wheel to the left, and to the right to operate the wheel to the right.



#### 4.2.1.3 Driving

- a) Press down the foot switch.
- b) Increase speed: Slowly move the drive control handle off center.
- c) Decrease speed: Slowly move the drive control handle toward center.
- d) Stop: Return the control handle to center or release the foot switch.

#### 4.2.2 Platform Leveling



**Only use the platform leveling function for slight leveling of the platform when the platform is in low position. Incorrect use could cause the load/occupants to shift or fail. Failure to do so could result in serious injury.**

Before platform level adjustment, identify the position of the platform. To Level Up or Down—Position the platform/Level control switch Up or Down and hold until the platform is level.

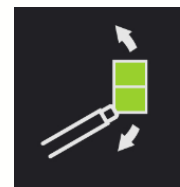

#### 4.2.3 Platform Rotation

To rotate the platform to the left or right, use the Platform Rotate control switch to select the direction and hold until desired position is reached.



### ⚠ WARNING

#### Note:

- a) Do not rotate the platform or raise upper boom above horizontal level when machine tilts.
- b) Do not use the tilt alarm as a chassis level indicator.
- c) To avoid tip over, lower platform to ground level. then drive machine to a level surface before raising upper boom.
- d) To avoid serious injury, do not operate machine if any control lever or toggle switch controlling platform movement does not return to the 'off' or neutral position when released.
- e) If the platform does not stop when a control switch or lever is released, remove foot from footswitch or use emergency stop switch to stop the machine.

### 4.2.4 Turntable Slewing

#### ⚠ CAUTION

**When swinging the turntable make sure there is ample room for the main boom to clear surrounding walls, partitions and equipment.**



Move the control handle on the platform or the control switch on ground to the 'Left' or 'Right' and the turntable will rotate left or right.

### 4.2.5 Raising and lowering the main boom

If necessary, place the main boom lift handle on the platform or the main boom lift switch on the ground in the 'up' or 'down' position to operate the boom up and boom down functions until the desired height is reached.



### 4.2.6 Telescoping the main boom

Move the telescoping switch to EXTEND or RETRACT position, the main boom could extend or retract.



### 4.2.7 Raising and Lowering the Jib

To raise or lower the Jib, position the Jib Lift to Up or Down until the desired height is reached.

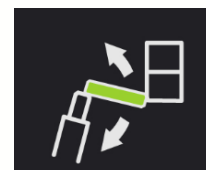

### 4.2.8 Emergency Stop

Push in the red “Emergency Stop” button on Ground or Platform Controls to off position to shut off all the functions.



Only after pressing the red "main power button" and "emergency stop" button can any operation function be restored.

### 4.2.9 Auxiliary Power



**Note:**

- a) When operating on auxiliary power, do not operate more than one function at a time.
- b) Compound operation is beyond the capability of auxiliary pump motor.
- c) A toggle type auxiliary power control switch is located on the platform control station and another is located on the ground control station. Operate the auxiliary power switch to turn on electric auxiliary pump at ground or platform mode if the main power system fails. The auxiliary pump will offer power for main boom lifting and telescoping, turntable rotating, jib lifting, and platform leveling and rotating.

Activating from the Platform Control Station:

- a) Turn key of SELECT switch to PLATFORM.



- b) Pull the Power/Emergency Stop switch to ON.



- c) Position Auxiliary Power switch to On and hold.



- d) Press down the foot switch.

- e) Operate appropriate control switch, lever or controller for desired function and hold.

- f) Release Auxiliary Power switch, selected control switch, level or controller, and footswitch.

- g) Position Power/Emergency Stop switch to Off.



### 4.2.10 Shut Down and Park

- a) Drive machine to a protected area.

- b) Assure main boom is fully retracted and lowered over rear (Drive) axle after removing loads.
- c) At Ground Controls, turn Key Select switch to (center) Off Position, Power/Emergency Stop switch (down) to Off. Remove key.
- d) All access panels and doors closed and secured.
- e) Cover Platform Control console to protect instruction placards, warning decals and operating controls from hostile environment.

#### 4.2.11 Battery charging

- a) Park beside the charging socket, and make sure the length of charging cable is appropriate;
- b) Shut down the machine;
- c) Select a proper adapter plug;
- d) Remove the original plug, connect the charging plug and the detection plug to the selected power adapter plug and the corresponding detection plug firmly, and tighten the plug to secure the end cover;
- e) Firmly connect the adapter plug to the charging socket, and observe for 30s. If the indicator flashes in green, the machine is charging normally.

Prevent the charging socket and charging cables from raining and splashing water to avoid short-circuit.

#### 4.3 Transport and Lifting

Observe and Obey:

- a) ZOOMLION provides this securement information as a recommendation. Drivers are solely responsible for making sure machines are properly secured and the correct trailer is selected pursuant to CHINA Department of Transportation regulations, other localized regulations, and their company policy.
- b) ZOOMLION customers needing to containerize any lift or ZOOMLION product should source a qualified freight forwarder with expertise in preparing, loading and securing construction and lifting equipment for international shipment.
- c) Only qualified aerial lift operators should move the machine on or off the truck.
- d) The transport vehicle must be parked on a level surface.
- e) The transport vehicle must be secured to prevent rolling while the machine is being loaded.
- f) Be sure the vehicle capacity, loading surfaces and chains or straps are sufficient to withstand the machine weight. ZOOMLION lifts are very heavy relative to their size. See the serial label for the machine weight.

- g) Be sure the machine is on a level surface or secured before releasing the brake.
- h) Do not drive the machine on a slope that exceeds the uphill, downhill or side slope rating. See Driving on a Slope in the Operating Instructions section.
- i) If the slope of the transport vehicle bed exceeds the maximum slope rating, the machine must be loaded and unloaded using a winch as described in the brake release operation.

**4.3.1 Release the brake while towing**

- a) Chock the wheels to prevent the machine from rolling.
- b) Release the wheel brakes by turning over all four drive hub disconnect caps.
- c) Be sure the winch line is properly secured to the drive chassis tie points and the path is clear of all obstructions.
- d) Reverse the procedures described to re-engage the brakes.

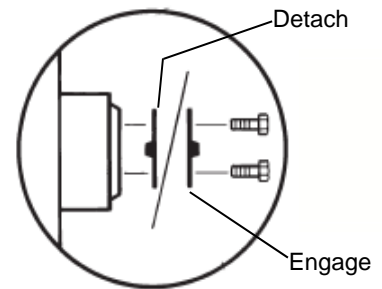

**Note: traction machine is not recommended. If the machine must be towed, the speed must not exceed 3.2 km/h (1.99mph).**

Every time the machine is transported, the turntable fixing pin should be turned off to lock the turntable.

No.1 Turntable fixing pin.

Turn the key switch to the off position and remove the key before transporting.

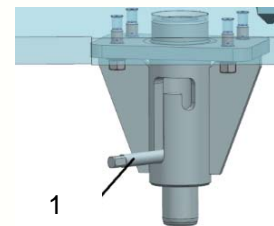

Inspect the entire machine for loose or unsecured items.

**4.3.2 Lifting**

- a) See serial label and “Technical Parameters” section in this manual for specific machine weight and total weight of the machine.
- b) Place the boom in the stowed position.
- c) Remove all loose items from the machine.
- d) Properly adjust the rigging to prevent damage to the machine and so the machine remains level.

**4.3.3 Securing the chassis**

- a) Use chains of ample load capacity.
- b) Use a minimum of 4 chains or belts.
- c) Pay attention to adjusting the tightening degree of each steel cable or chain, and adjust the rigging to make the force as uniform as possible to prevent damage to the chain.

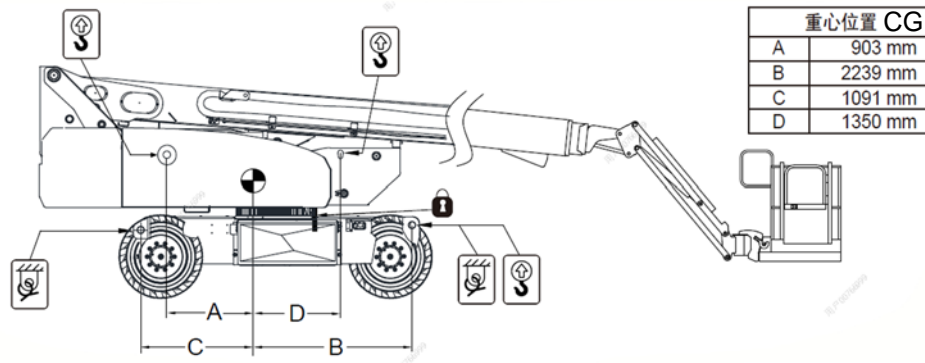

**Figure 4-1 Lifting and Securing Instructions**

### 4.3.4 Securing the platform

- Be sure the boom and the platform are in stowed position.
- Use the straps between the platform rotator (see Figure below) and platform base to secure the platform.
- Do not use excessive downward force when securing the boom section.

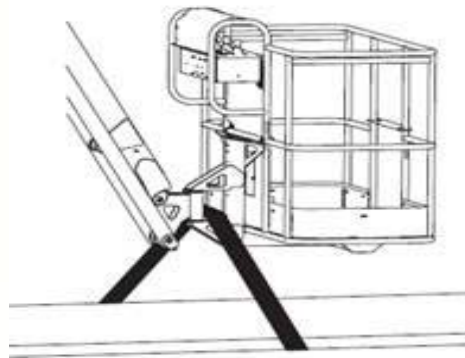

**Figure 4-2 Securing the Platform**

- Use a cable tie or rope to secure the slider to the upper square tube of the work platform to prevent the slider from bumping during transportation.

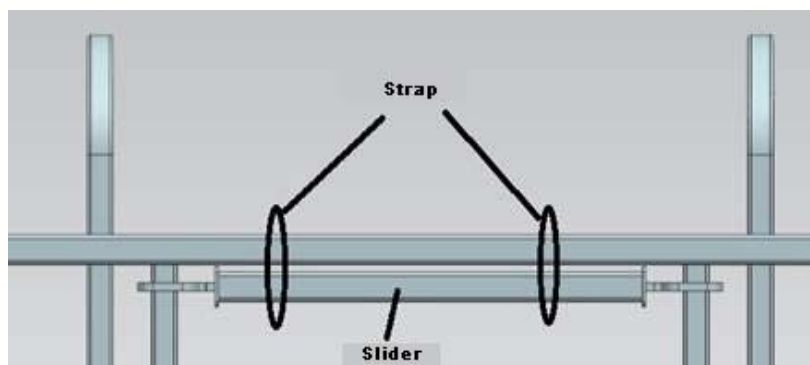

**Figure 4-3 Securing the Platform**

# **ZOOMLION**

**Operation and Safety Manual**

**Section 5 Maintenance**





## SECTION 5 MAINTENANCE

### 5.1 General



Observe and Obey:

- a) Only routine maintenance items specified in this manual shall be performed by the operator.
- b) Scheduled maintenance inspections shall be performed by qualified service technicians, according to the manufacturer's specifications and the requirements listed in the responsibilities manual.
- c) Disposal of materials should be according to the regulations of government and relevant environmental protection administration.
- d) Use only ZOOMLION approved replacement parts. ZOOMLION assumes no responsibility for hazards occurred to equipment and personnel caused by the use of unauthorized parts.

#### 5.1.1 Maintenance Symbols Legend

The following symbols have been used in this manual to help communicate the intent of the instructions. When one or more of the symbols appear at the beginning of a maintenance procedure, it conveys the meaning below.



Indicates that tools will be required to perform this procedure.



Indicates that new parts will be required to perform this procedure.



Indicates that a cold engine is required before performing this procedure.

#### 5.1.2 Pre-Start Inspection

- a) Be sure operator's, safety, and responsibilities manuals are complete, legible, and in the storage container located on the machine.
- b) Be sure all decals are in place and legible.
- c) Check for hydraulic oil leaks and proper oil level. Add oil if needed. See Maintenance section.
- d) Check for battery fluid leaks and proper fluid level. Add distilled water if needed after battery charged. Check the following components or areas for damage, improperly installed, or missing parts and unauthorized modifications:
  - 1) Electrical components, wiring, and electrical cables.
  - 2) Hydraulic hoses, fittings, cylinders, and manifolds.

- 3) Drive motor/motor.
- 4) Wear pads.
- 5) Tires and wheels.
- 6) Limit switches and horn.
- 7) Alarm and indicator (if equipped).
- 8) Nuts, bolts and other fasteners.
- 9) Brake release unit.

### 5.1.3 Maintenance hazards

- a) Shut off power to all controls and ensure that all moving parts are secured from inadvertent motion prior to performing any adjustments or repairs.
- b) Never work under an elevated platform until it has been fully lowered to the full down position, if possible, or otherwise supported and restrained from movement with appropriate safety props, blocking, or overhead supports.
- c) DO NOT attempt to repair or tighten any hydraulic holes or fittings while the machine is powered on or when the hydraulic system is under pressure.
- d) Always relieve hydraulic pressure from all hydraulic circuits before loosening or removing hydraulic components.
- e) DO NOT use your hand to check for leaks. Use a piece of card- board or paper to search for leaks. Wear gloves to help protect hands from ejective hydraulic oil.



### 5.1.4 Body injury hazard

Do not operate a machine with a hydraulic oil or air leak. An air leak or hydraulic leak can penetrate and/or burn skin. During or after a period of running of the hydraulic system, the parts may produce high surface temperature, and improper contact will cause burn to skin. Overhauling or adjusting any part of hydraulic system can cause serious injuries. Only trained maintenance personnel are allowed to repair or adjust the hydraulic system.

Suggestion: access by the operator is only advised when performing a pre-operation inspection. All covers must remain closed and secured during operation.

## 5.2 Hydraulic system maintenance

### 5.2.1 Check hydraulic oil

- a) Check the Hydraulic Oil Level



Maintaining the hydraulic oil at the proper level is essential to machine operation. Improper hydraulic oil levels can damage hydraulic components. Daily checks allow the inspector to identify changes in oil level that might indicate the presence of hydraulic system problems.

Be sure the machine is on a firm and level surface and in stowed position. By observing oil level in hydraulic oil tank, the hydraulic oil level after excluding air in the hydraulic system should reach the maximum scale mark on the hydraulic oil tank, and not be higher than bottom of the oil tank cap (different models have different maximum scale).

Add oil as needed. Do not overfill.

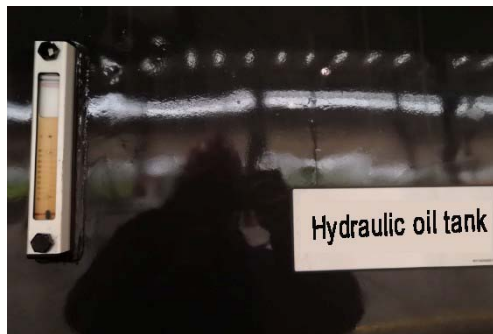

Figure 5-2 Hydraulic oil tank scale

- b) Hydraulic Oil Capacity

Table 5-3 Capacity

Model	ZT26JE	
Hydraulic tank	120 L	31.70 (us gal)
Hydraulic system (including	230 L	60.8 (us gal)

- c) Hydraulic Oil Specification

Please refer to the Table 5-4 below for the recommended type and model of hydraulic oil — Technical Parameters of Hydraulic Oil. Please select proper hydraulic oil according to the specific application environment of the equipment. For special environment or special requirements of users, please contact ZOOMLION or the hydraulic oil manufacturer.

Note: DO NOT mix oils of different brands or types, as they contain different additives which may cause negative effects. If mixing of hydraulic oils is unavoidable, permission must be obtained from the hydraulic oil manufacturer. After-sales service of ZOOMLION does not cover machine

malfunction caused by hydraulic oil mixing.

**Table 5-4 Technical Parameters of Hydraulic Oil**

Technical Parameters	Mobil SHC Aware H 32 (Eco-Friendly)	Mobil DTE 10 Ultra 22	Mobil DTE 10 Ultra 32	Mobil DTE 10 Ultra 46	Caltex Rando MV 22	Caltex Rando MV 32	Kunlun 10 aviation hydraulic fluid (Ground)	Great Wall L-HV 32	Great Wall L-HV 46	Great Wall 4632 grease non-flammable hydraulic oil N32 (Eco-Friendly)
<b>ISO Viscosity Grade</b>	32	22	32	46	22	32	10	32	46	32
<b>Pour Point °C/°F</b>	-30	-54	-54	-45	-36	-36	-50	-39	-37	-20
<b>Flash Point °C/°F</b>	185	224	250	232	190	210	92	231	240	270
<b>Motion Viscosity (40°C /104°F )</b>	32 cSt	22.4 cSt	32.7 cSt	45.6 cSt	22.5 cSt	33.5 cSt	10cSt ( 50°C /122°F )	33.4 cSt	48.7 cSt	28.8-35.2cSt
<b>VI viscosity index</b>	140	164	164	164	155	155	150	150	150	180

d) Hydraulic Oil Viscosity and Temperature Limit

Proper use of hydraulic oil: please note the corresponding oil viscosity and temperature limit. Under normal conditions, the recommended oil temperature should be controlled at 30 °C/86°F to 60°C /140 °F . The oil temperature affects the oil viscosity and the thickness of the oil film. High temperatures also shorten the service life of oil seals and other rubber components, and the oil also evaporates and oxidizes.

Pre-delivery of the machine, specific model of hydraulic oil shall be added as required by customer. If machine operating environment temperature is beyond the temperature limit of the hydraulic oil, different hydraulic oil suited to the actual conditions shall be used in time. On account of the safety

of machine components and work efficiency, it is advisable that the starting temperature should be 25°C/77°F higher than the pour point of hydraulic oil.

e) Changing Hydraulic Oil

We suggest that changing time of the hydraulic oil is as follows:

- 1) first changing: operating for 500 hrs after commissioning.
- 2) second and subsequent changing: every 2,000 hrs of operation or once a year.

The above recommended intervals are suitable for most applications. Higher temperatures and pressures will shorten the oil's service life, so the hydraulic oil should be changed sooner than the recommended. For small load work, the oil change time can be extended.

Cleanliness of the hydraulic oil upon delivery is NAS9 (ISO4406 18/15), and for normal operation, the cleanliness should not be lower than NAS10 (ISO4406 19/16). We suggest that the hydraulic oil should be checked every 6 months, and the oil should be sampled at least once upon the time for oil changing. The oil sample can be sent to the hydraulic oil manufacturer or qualified third-party testing agency for analysis and to determine whether it is still usable.

f) Changing Oil Return Filter

The oil return filter is recommended to be changed every 300 hrs of operation or every half a year, whichever comes first. Proper filter condition is essential to good machine performance and service life. Dirty or clogged filters will affect machine performance and damage components. Under hostile environment and bad operating conditions, the filter should be checked and replaced more frequently.

## 5.3 Battery Maintenance

### Battery Inspection



Proper battery condition is essential to good machine performance and operational safety. Improper fluid levels or damaged cables and connections can result in component damage and hazardous conditions.

Note: this inspection is not required for machines with sealed or non-maintainable batteries.

Check electrolyte level of the battery every two weeks. Fully charge the battery before adding water. If the electrolyte level is much higher than the plate, then no need to add water.



### Electrocution hazard

**Contact with hot or live circuits may result in death or serious injury. Remove all rings, watches and jewelry.**

**⚠ WARNING****Body Injury Hazard**

**Batteries contain acid. Avoid spilling or contacting battery acid. Neutralize battery acid spills with baking soda and water.**

Note: the battery should be fully charged before this inspection.

- a) Only qualified riggers should rig the machine.
- b) Only certified crane operators should lift the machine and only in accordance with the applicable crane regulations.
- c) Be sure that the battery hold-down brackets are in place and secure.

Note: adding terminal protectors and a corrosion preventative sealant will help eliminate the corrosion on the battery terminals and cables.

## 5.4 Regular Maintenance

Maintenance performed quarterly, annually and every two years must be completed by a person trained and qualified to perform maintenance on this machine according to the procedures found in the service manual for this machine.

Machines that have been out of service for more than three months must receive the quarterly inspection before they are put back into service.

Note: lubrication intervals are based on machine operation under normal conditions. For machines used in multi-shift operations or exposed to hostile environments or conditions, lubrication frequencies must be increased accordingly.

### 5.4.1 Swing drive

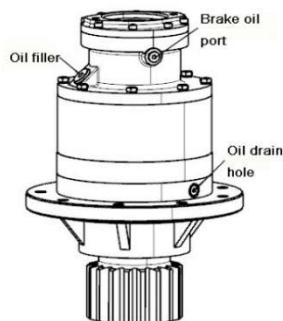

**Figure 5-3 Swing drive**

Lube Point(s) –Replaceable Filter.

Capacity –As required.

Lube Point(s) –Changcheng 7408B-1 Gear Grease.

Interval –Every 3 months or 150 hours.

Comment –Apply grease and rotate in 90 degree intervals until bearing is completely lubricated.



**DO NOT over-lubricate the bearings, otherwise it will cause damage to outside seal of casing.**

### 5.4.2 Hydraulic reservoir

Liquid Level –110-120L/29-31.7us gal.

Interval –Check level daily; Change every year or 2,000 hours of operation.

Comment –On new machines, those recently overhauled, or after changing hydraulic oil, operate all system a minimum of two complete cycles and recheck oil level in reservoir.

#### a) Hydraulic Return Filter



**Figure 5-4 Hydraulic return filter**

Maintenance Point(s) –Replaceable Element.

Interval –Change after first 50 hrs. and every 6 months or 300 hrs.

#### b) Hydraulic Tank Breather



**Figure 5-5 Hydraulic Tank Breather**

Maintenance Point(s) –Tank Breather.

Interval –Change after first 50 hrs. and every 6 months or 300 hrs thereafter.

Comment –Remove wing nut and cover to replace. Under certain conditions, it may be necessary to

replace on a more frequent basis.

### 5.4.3 Drive hub

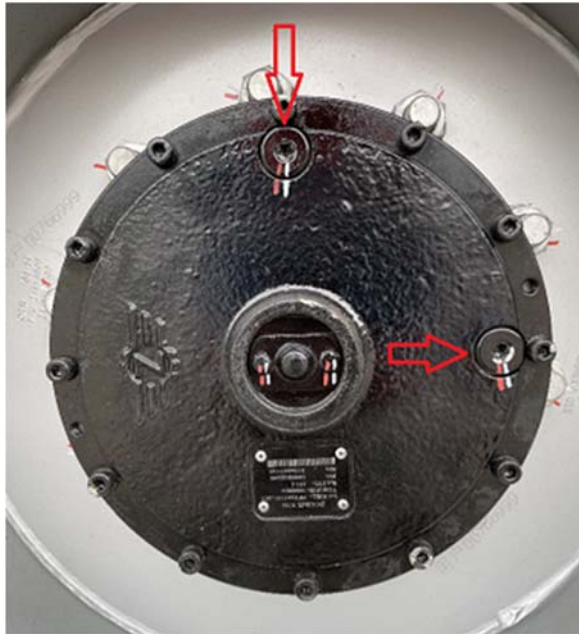

**Figure 5-6 Travel Reducer**

Lube Point(s) –Level/Fill Plug.

Capacity –About 1.8L/0.48us gal.

Gear oil type-*SAE80W/90 Industrial Gear Oil for Close Motor.*

Interval –Check level every 3 months or 150 hours of operation; change every 2 years or 1,200 hours of operation.

## 5.5 Tire and Wheel

### 5.5.1 Tire replacement

ZOOMLION recommends a replacement tire be the same size, ply and brand as originally installed on the machine. Please refer to the ZOOMLION Parts Manual for the part number of the approved tires for a particular machine model. If not using a ZOOMLION approved replacement tire, we recommend that replacement tires have the following characteristics:

- a) Equal or greater ply/load rating and size of original.
- b) Tire tread contact width equal or greater than original.
- c) Wheel diameter, width, and offset dimensions equal to the original.
- d) Approved for the application by the tire manufacturer (including inflation pressure and maximum tire load).



Unless specifically approved by ZOOMLION do not replace a foam filled or ballast filled tire assembly with a pneumatic tire. When selecting and installing a replacement tire, ensure that all tires are inflated to the pressure recommended by ZOOMLION. Due to size variations between tire brands, both tires on the same axle should be the same.

### 5.5.2 Wheel and tire replacement

The rims installed on each product model have been designed for stability requirements which consist of track width, tire pressure, and load capacity. Size changes such as rim width, center piece location, larger or smaller diameter, etc., without written factory recommendations, may result in an unsafe condition regarding stability.

### 5.5.3 Wheel installation

It is extremely important to apply and maintain proper wheel mounting torque.



**Wheel nuts must be installed and maintained at the proper torque to prevent loose wheels, broken studs, and possible dangerous separation of wheel from the axle.**

Tighten the lug nuts to the proper torque to prevent wheels from coming loose. Use a torque wrench to tighten the fasteners. If you do not have a torque wrench, tighten the fasteners with a lug wrench, then immediately have a service garage or dealer tighten the lug nuts to the proper torque. Over-tightening will result in breaking the studs or permanently deforming the mounting stud holes in the wheels. The proper procedure for attaching wheels is as follows:

- a) Start all nuts by hand to prevent cross threading. DO NOT use lubricant on threads or nuts.
- b) Tighten nuts in the following sequence.



**Figure 5-14 Hub bolt**

- c) The tightening of the nuts should be done in stages. Following the recommended sequence, tighten nuts per wheel torque.

**Table 5-5 Wheel Torque Table**

<b>Torque Sequence</b>		
<b>1st Stage</b>	<b>2nd Stage</b>	<b>3rd Stage</b>
130 Nm/96ftlb	230 Nm/170ftlb	400 Nm/295ftlb

- d) Wheel nuts should be torqued after first 50 hours of operation and after each wheel removal. Check and torque every 3 months or 150 hours of operation.

# **ZOOMLION**

**Operation and Safety Manual**

**Section 6 Storage and Ex-Factory Test**



## SECTION 6 STORAGE AND EX-FACTORY TEST

### 6.1 Storage Conditions

Ambient temperature for machine storage and transportation should be between  $-20^{\circ}\text{C}/-4^{\circ}\text{F}$  and  $40^{\circ}\text{C}/104^{\circ}\text{F}$ , with relative humidity not greater than 85% and 100% only for short-term.

### 6.2 Ex-factory Test Items

Machine must complete testing items in the following table before delivery:

**Table 6-1 Testing Items Before Delivery**

Tests Items	Load Testing		Testing Movement
<b>Overload Test</b>	125%	567kg/1250lb	Lift the platform within the range of motion
<b>Functional Test</b>	100%	300kg/660lb	Traveling & Platform Lifting
<b>Braking Test</b>	100%	300kg/660lb	Max Speed of Forward & Reverse Traveling



# **ZOOMLION**

**Operation and Safety Manual**

**Section 7 Technical Parameter**





**SECTION 7 TECHNICAL PARAMETER**

**Table 7-1 Technical parameter**

	<b>Model</b>	<b>ZT26JE</b>
<b>Size</b>	Work Height	28.7 m
	Platform Height	26.7 m
	Horizontal Outreach	22. 1 m
	Overall Length (Stowed)	11910 mm
	Overall Width (Stowed)	2490 mm
	Overall Height (Stowed)	2820 mm
	Platform Length	2440 mm
	Platform Width	910 mm
	Wheelbase	2800 mm
	Ground Clearance	410 mm
<b>Performance</b>	Platform Capacity (Unrestricted / Restricted)	300/454 kg
	Drive Speed	5.5 km/h
	Gradeability	45%(24°)
	Turning Radius (Inside)	3.11 m
	Turning Radius (Outside)	6.16 m
	Turntable Swing	360° continuous
	Platform Rotation	±90°
	Jib Rotation	130° ( - 55°~75°)
	Max. Allowable Angle of Chassis	5°
	Max. Wind Speed	12.5 m/s
<b>Power</b>	Battery	80V/460Ah
	Charger	6KW/80V
	Drive Motor	5.2KW
	Lift Motor	30KW
	Hydraulic Tank Capacity	120 L
<b>Tire</b>	Tires Type	15-625 foam-filled
<b>Weight</b>	Gross	17600 kg

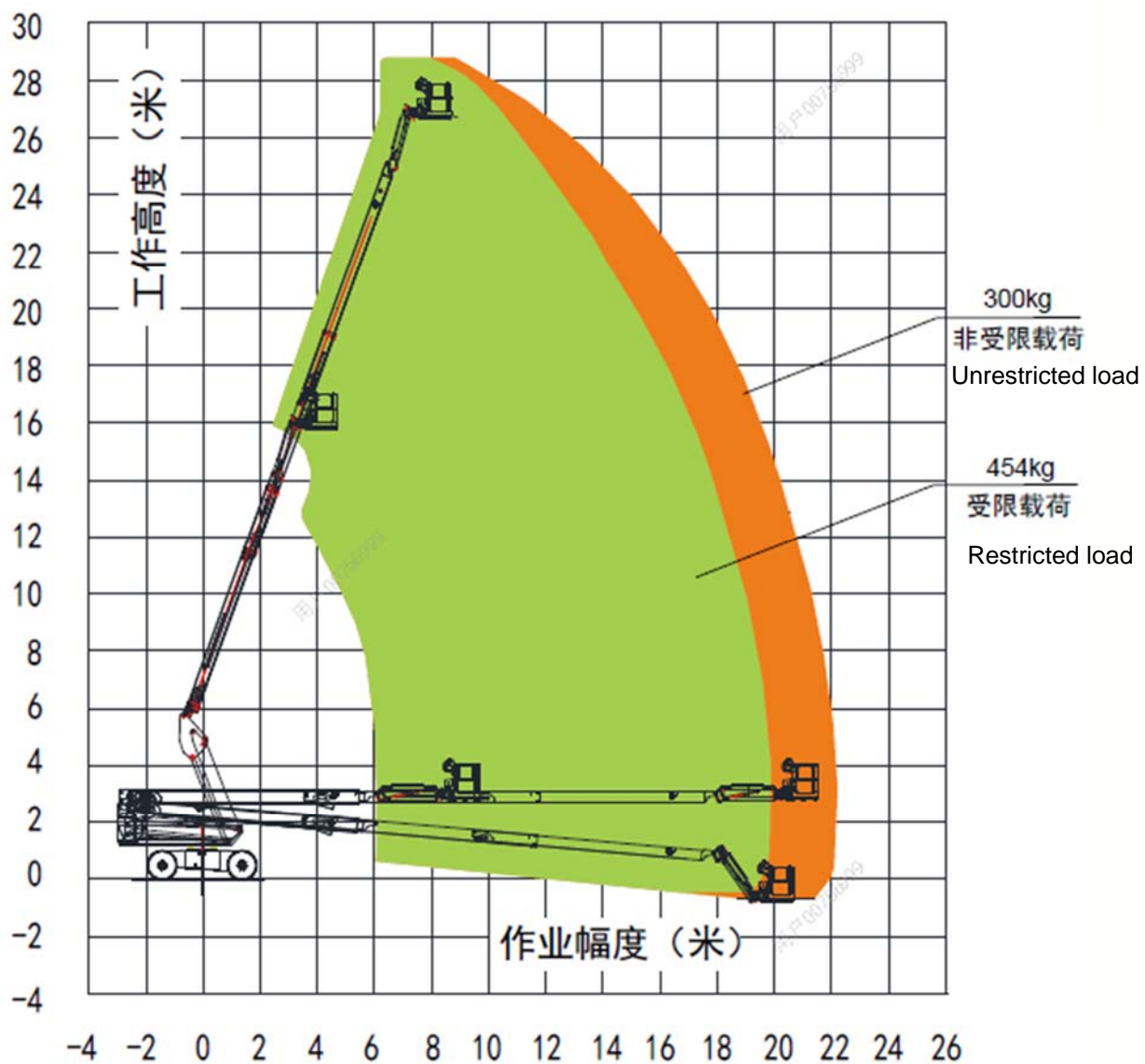

Figure 7-1 ZT26JE Range of Motion

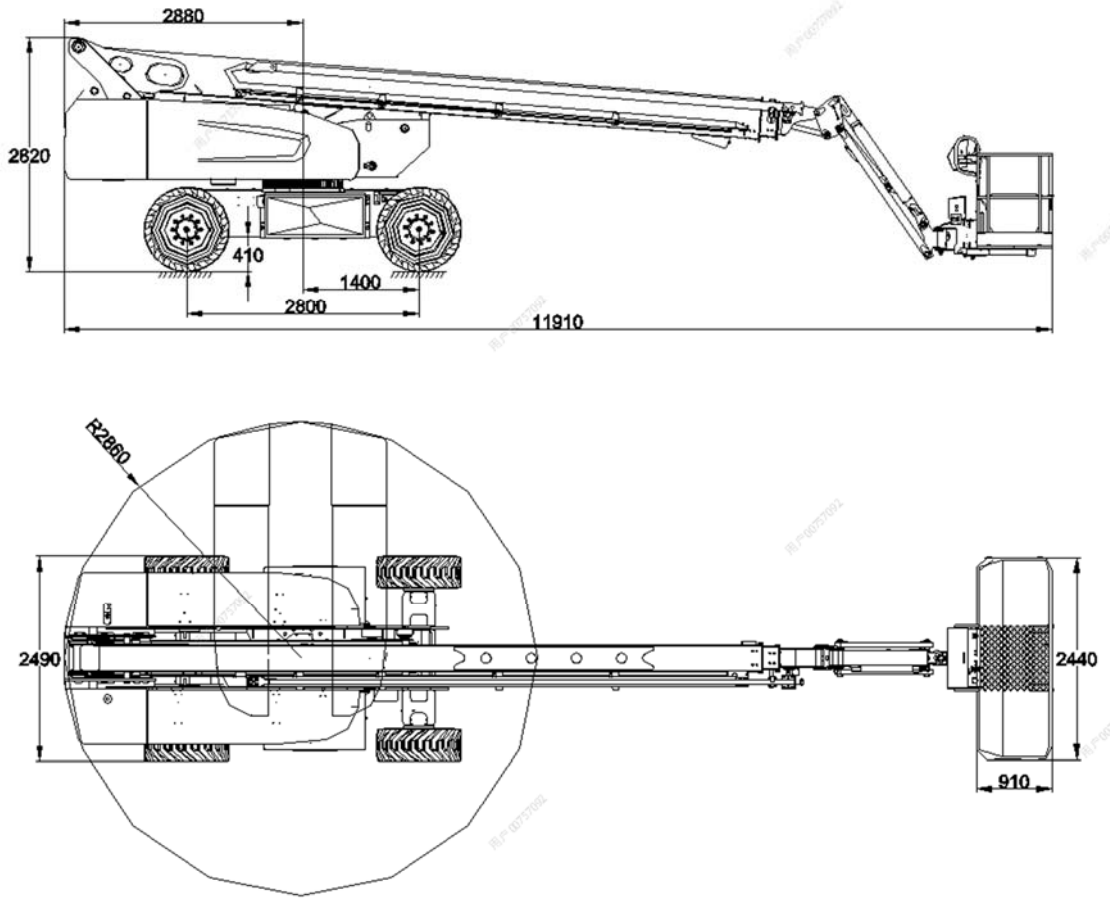

Figure 7-2 ZT26JE Dimension (stowed)



# ZT26JE

## Operation and Safety Manual

**ZOOMLION INTELLIGENT ACCESS MACHINERY CO.,LTD.**

Add:Tengfei Road 997 , Wangcheng District, Changsha, Hunan,PRC

Zip Code:410200

E-mail:awm@zoomlion.com

Tel:400-800-0157



**ZOOMLION**