

HOEFLON®

USER MANUAL

COMPACT CRANE C6e



Serial no.:

Delivery date:

Reference: U.C6.01.04.EN

Version: 1.0

VERSION MANAGEMENT

Version 1.0	01-01-2020	From serial number xxxx xxxx

Manufacturer

Hoeflon International B.V.
Zwolleweg 2
3771 NR Barneveld

T: +31(0)342 400 288

I: www.hoeflon.com

E: info@hoeflon.com

INTELLECTUAL PROPERTY RIGHTS

All rights reserved.

No part of this publication may be reproduced, stored in a retrieval system, or transmitted in any form or by any means (electronically or mechanically, including photocopying, recording or otherwise) without the prior written permission of Hoeflon International B.V. This also applies to the accompanying drawings and charts.

© Copyright 2020 Hoeflon





PREFACE

This user manual has been written for the type C6E compact cranes. Throughout the rest of this document both types will simply be referred to as 'compact crane'. Read this entire user manual carefully to become familiar with the correct operation and maintenance of the compact crane. If you choose to ignore the guidelines and instructions in this user manual you do so entirely at your own risk, and bodily injury and damage to the machine may result.

Hoeflon International B.V. recommends that the original copy of this user manual, including all the annexes, be kept in a safe, central place. It is also a good idea to keep a copy of this user manual near the machine at the workplace. For technical support, please contact the manufacturer (see details on the cover).

NOTES FOR THE READER

The instructions, recommendations and warnings in this user manual are accompanied by the following terms/pictograms. Read these instructions carefully.

	TIP	A 'Tip' provides the user with suggestions and advice that will make it easier or more convenient to perform certain tasks.
	VOORZICHTIG!	'Caution!' The operation may be dangerous. 'Caution!' indicates that damage to the machine may occur if the user does not perform the procedures with due care.
	WAARSCHUWING!	'Warning!' The user may injure himself or seriously damage the machine. A warning indicates a situation in which the user may be harmed or damage may occur to the machine, tool or load if the user does not perform the procedures carefully.
	LEVENSGEVAAR!	'Danger!' Warns that a hazard or hazardous condition may be life threatening.

INHOUDSOPGAVE

VERSION MANAGEMENT	2
INTELLECTUAL PROPERTY RIGHTS	2
PREFACE	3
NOTES FOR THE READER	3
INHOUDSOPGAVE	4
1. INTRODUCTION	7
1.1 Introduction	7
1.2 EC Declaration of Conformity	7
1.3 Changes	7
2. GENERAL DESCRIPTION	8
2.1 Intended purpose	8
2.2 Major components of compact crane	8
2.3 Technical data	10
2.3.1 Technical specifications	10
2.3.2 Drawings	12
2.3.3 Sound pressure level	13
2.3.4 Hydraulic system	13
2.3.5 Electrical system	13
2.4 Type plate	14
3. GENERAL INSTRUCTIONS FOR USE	15
4. WARRANTY	16
5. SAFETY	17
5.1 Operating personnel	17
5.2 Warnings	17
5.3 Emergency stop	22
5.4 Emergency operation	22
5.5 Pictograms	22
5.6 Stack light	24
5.7 LML	25
6. WORKING WITH THE COMPACT CRANE	26

6.1	Daily inspection prior to use _____	29
6.2	Controls _____	30
6.2.1	Remote control _____	30
6.2.2	Function mapping _____	33
6.2.3	Calibrating levers _____	34
6.2.4	Changing transmitter battery _____	35
6.2.5	Electrical cabinet _____	36
6.2.6	State of charge of battery packs _____	37
6.3	Crane operation/control _____	38
6.3.1	Work sequence _____	38
6.3.2	Operation _____	38
6.3.3	Guiding the load _____	39
6.4	Driving the compact crane. _____	40
6.4.1	Sequence of operations for starting crane _____	41
6.4.2	Crawler track width adjustment _____	41
6.4.3	Transport position _____	41
6.5	Use of the outriggers _____	42
6.5.1	Work sequence _____	43
6.5.2	Operation _____	44
6.5.3	Nodding outrigger legs option. _____	45
6.5.4	Interpreting the display while setting the outriggers _____	46
6.6	Attachment/Removal _____	47
6.6.1	Jib _____	47
6.7	Winch operation/control _____	49
6.7.1	Order of operations without options _____	50
6.7.2	Order of operations for use with jib _____	53
6.7.3	Order of operations winch head and manual jib extension plus additional 30 degree adjustable section _____	54
6.7.4	Positions of winch head in 30° section when used with main boom _____	56
6.7.5	Positions of winch head in 30° section when used with jib _____	57
6.7.6	Limits _____	58
6.7.7	Attaching winch weight _____	60
6.7.8	Winch stop _____	62
6.7.9	Explanation of display during lifting _____	63
6.7.10	Extending/retracting ballast _____	64
6.8	Pick and carry _____	64

7. MAINTENANCE / TROUBLESHOOTING	65
7.1 General	65
7.2 Maintenance work	66
7.3 Maintenance schedule	67
7.4 Lubrication chart	69
7.5 Lubricant specifications	70
7.5.1 Boom extension and retraction chains	70
7.6 Use of start assistance terminals	71
7.6.1 Preparation	71
7.6.2 Procedure	71
7.7 Removing/installing ballast	72
7.7.1 Removing with your own equipment	72
7.7.2 Removing with external equipment	76
7.7.3 Fitting ballast with your own equipment	77
7.8 Troubleshooting	78
7.8.1 Fault codes	80
8. TRANSPORT, STORAGE, DISPOSAL	86
8.1 Transport	86
8.1.1 General	86
8.1.2 Securing	87
8.2 Storage	88
8.3 Disposal	88
9. ANNEXES	89
9.1 Load chart C6E	90
9.2 Outrigger pressure	91
9.3 Annexes	92

1

INTRODUCTION

1.1 Introduction

The purpose/function of this user manual is to establish safe and efficient interaction between man and machine. The information in this user manual plays an important role in ensuring the safe and proper operation of the machine.

Read this user manual carefully from beginning to end. Hoeflon International B.V. also recommends a (brief) compulsory training and instruction session for all new users (operators, technicians, maintenance personnel and possibly even cleaners), for which this manual can serve as a starting point.

Contact your supplier's technical department for additional information concerning aspects such as maintenance and repair of specific machine parts. This user manual has been written with the greatest possible care and with the intention of making it as complete as possible. Nevertheless, continuous safety vigilance in both familiar and unfamiliar situations is always necessary.

1.2 EC Declaration of Conformity

Hoeflon International B.V. declares that the compact crane meets the requirements of the applicable European Directives. The EC Declaration of Conformity is attached as an annex.

1.3 Changes

Changes may only be made to the compact crane after written consultation with Hoeflon International B.V. These changes must be documented in the crane logbook.

All changes to the machine must be documented in this user manual as well as in all copies. The party that makes the changes is responsible for doing so.

Hoeflon International B.V. reserves the right to make immediate adaptations or changes that improve the safety of the machine at any time. These adaptations or changes will be documented in an annex to this user manual. The content of this user manual can also be changed without prior notice.

2

GENERAL DESCRIPTION

2.1 Intended purpose

The compact crane is exclusively intended for lifting loose materials using a hook. The objects to be transported must fall within the specifications described in this user manual and the corresponding crane logbook.

2.2 Major components of compact crane

The components of the compact crane are shown below.



Figure 1: Right-side view C6

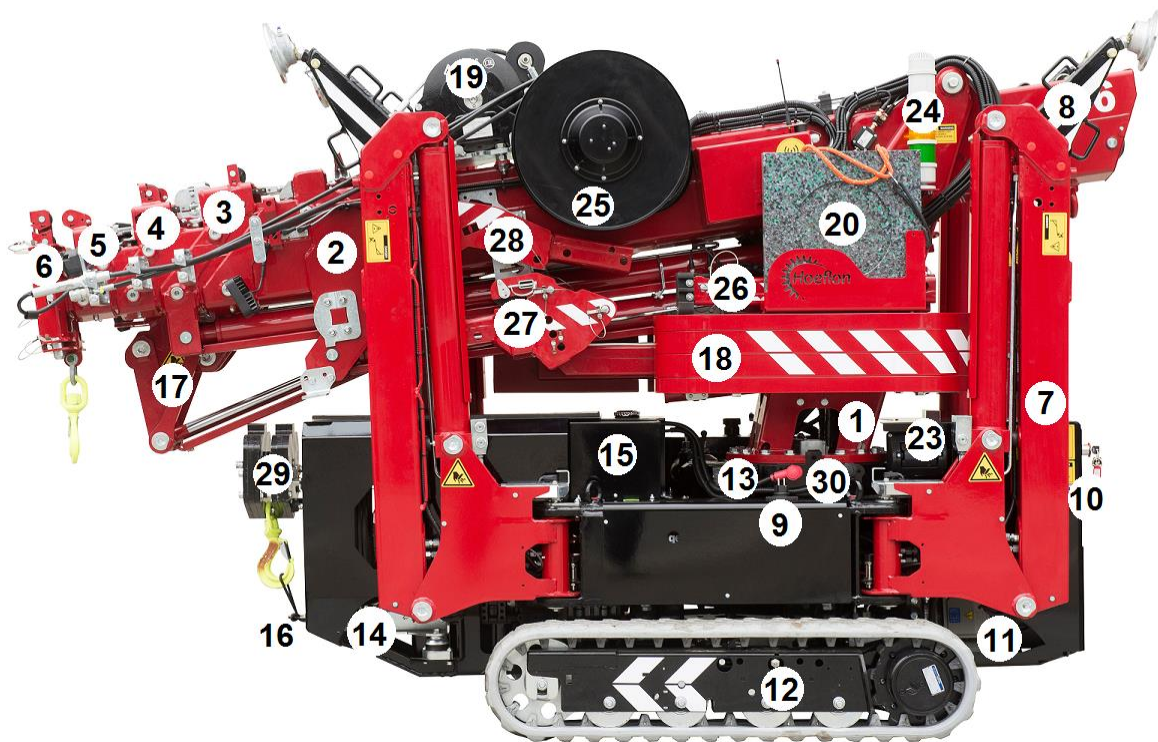

Figure 2: Left-side view C6

- | | |
|---------------------------|--|
| 1 Crane column | 17 Jib |
| 2 Boom 1 | 18 Ballast |
| 3 Extension jib 1 | 19 Hoisting winch |
| 4 Extension jib 2 | 20 Outrigger pads |
| 5 Extension jib 3 | 21 Toolbox |
| 6 Extension jib 4 | 22 Hydraulic oil tank |
| 7 Outrigger leg | 23 Battery charger (for transmitter battery) |
| 8 Outrigger leg extension | 24 Stack light |
| 9 230 V connection | 25 Hydraulic/electric reel |
| 10 Electrical cabinet | 26 Manual jib extension |
| 11 Valve block | 27 30° section |
| 12 Track undercarriage | 28 Winch head |
| 13 Turntable | 29 Winch weight |
| 14 Battery pack | 30 Charging point 24V |
| 15 Battery | 31 n/a |
| 16 Pulling eye | |

2.3 Technical data

2.3.1 Technical specifications

The technical data for the compact cranes are shown below.

General data		
Machine brand	Hoeflon	
Serial number	03 12 1089 C6 (1089=service number)	
Jib weight	150	kg
Maximum slope angle	15	°
Clearance angle	20	°
Max. lean angle with outriggers extended	5	°
Ground clearance	131	mm
Electric motor	80V 9.5kW	
Battery (system voltage 24V)	2x 12V, 12Ah	
Battery pack (drive)	1x 80V 5.5kW (option: 2x 80V 5.5kW)	
Ambient temperature	-10 to 40	°C
Slewing angle	360	°
Max. working load and lifting point of crane	See load table provided in the annexes	
Maximum wind speed	10.8 (6 Beaufort)	m/s
Centre of gravity	Below lifting hook at top of the boom, and 950 mm from underside of crawler track.	

Technical data	C6	
Transport length without jib	2692	mm
Transport width	750	mm
Transport height	1750	mm
Max. outer dimensions with outriggers extended at 45°	4440x4220	mm
Total weight incl. jib and any ballast	2800	kg
Total weight jib	150	kg
Total weight jib tube	18	kg
Total weight ballast	600	kg
Weight of winch weight with hook	33	kg
Weight of winch head	13	kg
Maximum ground pressure per surface area	15	kg/cm ²
Maximum outrigger pressure per outrigger	3300	kg
Max. load jib horizontal retracted	900	kg
Max. load jib horizontal extended	514	kg
Max. winch load	1000	kg
Max. reeving	1x reeving 2000 kg 2x reeving 3000 kg	

2.3.2 Drawings

The views of the compact crane are shown below.

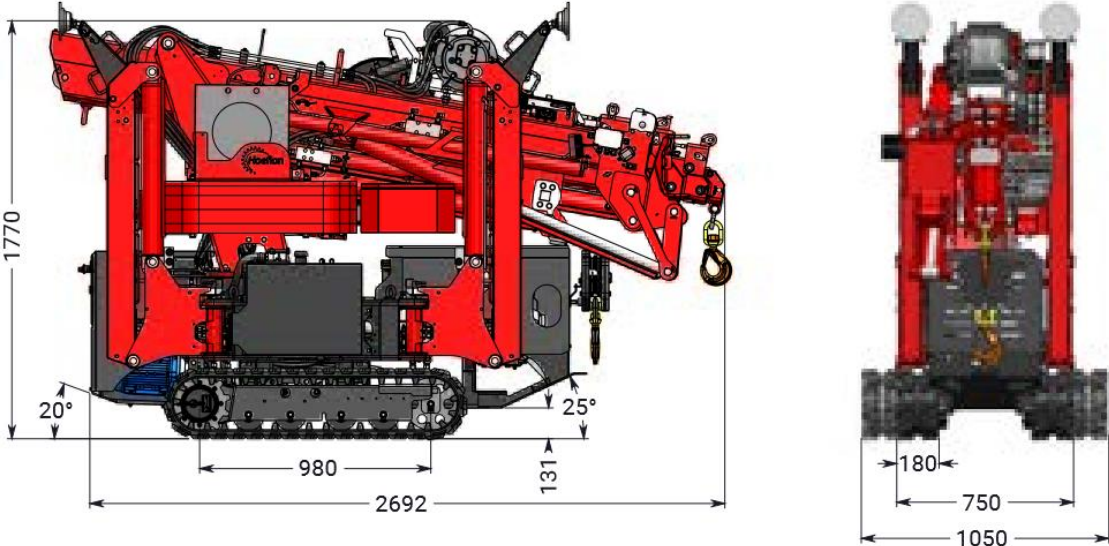

Figure 3: front and side view C6

2.3.3 Sound pressure level

The noise measurements were conducted on a flat surface.

Noise level dB(A)		8 metres	16 metres
Front, motor side	Electric motor		
Rear	Electric motor		

2.3.4 Hydraulic system

The specifications for the hydraulic system are shown below.

Hydraulic system		
Volume of hydraulic tank	16 litres	
Pump 1	Type	Gear pump
	Max. pressure	250 bar

2.3.5 Electrical system

The specifications for the electrical system are shown below.

Electrical system	
Battery (electrical system)	24 V (2x 12 V)
Battery packs (drive)	80V 5.5kW (Lithium)
Electric motor	80 VDC, 9.5kW
Remote control	Hoeflon RC6
Charger	230 V single phase



TIP

For more technical specifications, see the corresponding crane logbook and the user manual for the motor.

2.4 Type plate

A type plate containing the machine data is mounted on the compact crane. This type plate may not be removed.

The CE Marking is shown on the type plate to show that the compact crane meets the requirements of applicable European Directives.



Figure 4

Type plate explanation	
Type	The type of compact crane (C6E)
Model	The brand of the compact crane
Serial no.	The serial number of the compact crane
Year	The year in which the compact crane was built
Weight	The weight of the compact crane
Max. capacity	Maximum working load

	<p>TIP</p>	<p>Please provide the type number and serial number when ordering parts.</p>
---	-------------------	--

3

GENERAL INSTRUCTIONS FOR USE

The compact crane is a machine intended for lifting loads. It is only permitted to use the compact crane for the intended uses. Additionally, you are not permitted to change movement speeds on your own. It is also absolutely forbidden to exceed the maximum working load (see sections 9.1 and 9.2), and it is forbidden to bypass sensors. If changes are desired, you must contact the manufacturer.

Before the machine is put in use the user must be sufficiently familiar with this user manual. All the instructions and safety warnings in this user manual must be followed. Any use other than the permitted use may result in danger to users and bystanders. Moreover, the machine may be damaged. It is not permitted to use the machine in a way other than prescribed without express written permission from Hoeflon International B.V.

Your machine has a self-monitoring safety system. This means that sensors monitor the position/configuration of the machine as well as the load. This data is stored in the crane.

Every employee must be familiar with all the instructions in this user manual. Failure to heed this requirement is considered to be negligence.

4

WARRANTY

A new compact crane is covered by a 12-month warranty.

The warranty starts on the day the compact crane is first put in use. This is also the day that is stated on the delivery receipt (see page 3).

If changes are made to the crane by anyone other than a Hoeflon International B.V. employee, the warranty will be void.

No warranty is given on the following parts:

- Imitation parts or parts that were not ordered from Hoeflon International.
- Labour charges for installation/repair of the compact crane.
- Parts that have become defective due to incorrect/improper use, overloading, lack of maintenance, incompetence, accidents, normal wear, etc.
- Parts required for scheduled maintenance.
- If a filled in delivery receipt is not returned to Hoeflon International B.V.,
- reimbursement will only be provided for the parts.

The full terms and conditions of the warranty are available from your dealer on request.

5







SAFETY

5.1 Operating personnel

Operating personnel may not be under the influence of narcotics or alcohol and must be at least 18 years of age. These persons must be familiar with all the functions and tools associated with this lifting machine. Persons who work with the compact crane must wear safety shoes, gloves and a safety helmet.

5.2 Warnings

Every employee must heed the following warnings/regulations.

	LEVENSGEVAAR!	Lifting with the boom below horizontal is prohibited, due to the extension and retraction chains. With the jib lower than horizontal is allowed.
	LEVENSGEVAAR!	Never allow unauthorised persons to come within the working range of the machine while it is in operation. Never swing a suspended load over people.
	LEVENSGEVAAR!	It is prohibited to lift loads with a damaged or weakened hook, cable or other lifting equipment.
	LEVENSGEVAAR!	Avoid contact with rotating and moving parts.
	LEVENSGEVAAR!	It is prohibited to use the compact crane in the vicinity of high voltage cables!
	LEVENSGEVAAR!	Never climb on the machine when it is in motion or when it is being used.



LEVENSGEVAAR!

It is prohibited to use the compact crane in an explosive environment.



LEVENSGEVAAR!

Never transport the compact crane without first ensuring that the crane, outriggers and ballast are fully collapsed, retracted and locked, and there is no load on the crane; otherwise there is a risk of dangerous situations and possible damage to the machine!



LEVENSGEVAAR!

Make sure the load bearing capacity of the ground is adequate; use access mats or outrigger pads. Caution: never on manholes or beside/in holes.



LEVENSGEVAAR!

It is prohibited to use the compact crane to transport or lift persons.



LEVENSGEVAAR!

It is prohibited to use the compact crane to pull loads free, cause them to fall, push them or pull them at an angle.



LEVENSGEVAAR!

It is prohibited to bypass a sensor; doing so can cause danger to life and damage to the machine. Contact Hoeflon International B.V. immediately in the event of a defective sensor.



LEVENSGEVAAR!

It is prohibited to change the pressure settings and the motor speed as this can lead to dangerous situations and damage to the machine and renders the warranty immediately invalid.



LEVENSGEVAAR!

Never lift heavier loads than the maximum permitted workload according to the table.



LEVENSGEVAAR!

Never leave the compact crane unattended with a load hanging from the machine.













LEVENSGEVAAR!

Only move loads that can move freely from the surface they are sitting on and that are located directly beneath the hook!











LEVENSGEVAAR!

Remove the key from the key switch when operating the crane; prevent unauthorised persons from switching the machine on or off.

	<p>LEVENSGEVAAR!</p>	<p>Do not raise the boom more than 60° if the outrigger legs on the ballast side are positioned parallel (180°) to the compact crane! Otherwise the compact crane may tip over.</p>
	<p>LEVENSGEVAAR!</p>	<p>Never place materials or tools on the motor shroud of the machine or on the crane. These parts can be knocked off by the motor or fall off of the machine.</p>
	<p>LEVENSGEVAAR!</p>	<p>It is prohibited to use the compact crane in stormy weather and/or in wind speeds in excess of Beaufort Force 6.</p>
	<p>LEVENSGEVAAR!</p>	<p>High voltage!! (Danger of electrocution) It is prohibited to remove the rear cover and front covers of the undercarriage. Behind them are battery packs, cables and components that operate under high voltage. This may only be done by technicians specially trained by Hoeflon.</p>
	<p>WAARSCHUWING!</p>	<p>Only suitable, trained persons who are familiar with the content of this user manual and have completed the user training provided by Hoeflon International B.V. may operate or work with the compact crane!</p>
	<p>WAARSCHUWING!</p>	<p>Dangerous situations can arise in which there is intense interaction between the machine, the operator, the load, the surroundings and the ground. Thorough knowledge and preparation is a must.</p>
	<p>WAARSCHUWING!</p>	<p>It is not advisable to use the electric drive system in rain, snow, or high or wet grass or to drive through water.</p>
	<p>WAARSCHUWING!</p>	<p>It is prohibited to use the compact crane on public roads; the compact crane does not have the proper markings and lighting for this.</p>
	<p>WAARSCHUWING!</p>	<p>Hot parts of the motor and components of the hydraulic system can cause burn injuries.</p>
	<p>WAARSCHUWING!</p>	<p>When disconnecting hydraulic lines and hoses, precautionary measures must be taken to ensure that the line/hose is no longer under pressure once the supply of energy to the system has been switched off.</p>

	WAARSCHUWING!	Ensure that the outrigger legs are not extended too far to prevent contact between the ballast and outrigger legs during slewing.
	WAARSCHUWING!	It is prohibited to raise the jib beyond 70°.
	WAARSCHUWING!	Avoid contact with the outrigger legs when setting or retracting the outriggers (crushing danger).
	WAARSCHUWING!	Never transport a loaded compact crane, except with pick and carry option.
	WAARSCHUWING!	Always collapse the crane after use in case of possible windy conditions when not in use.
	VOORZICHTIG!	Mind the height restriction in covered areas.
	VOORZICHTIG!	When working in a poorly lit environment, artificial light must be used to ensure that operations involving the compact crane can be performed safely.
	VOORZICHTIG!	Make sure there are no loose parts present on the boom during lifting operations.
	VOORZICHTIG!	The boom is flexible and bends when lifting the load. Be aware that when the load is released the boom will bend back.
	VOORZICHTIG!	The lifting point on top of the jib is only intended for lifting the loose jib; it is forbidden to use it to lift a load or lash the machine in place.
	VOORZICHTIG!	Take extra caution and safety measures in situations where the ground, the surroundings or the load strongly influences or restricts the use of the machine. When in doubt about the safe use of the machine, get advice from a specialist or contact your dealer or the manufacturer.

	VOORZICHTIG!	Maintain a close watch on the active outrigger leg during extension to prevent foot entrapment.
	VOORZICHTIG!	The compact crane may only be moved by means of hold-to-run control. Always maintain a good view of the surrounding area, to avoid hitting people or objects.
	TIP	Use communication equipment if the operator does not have a complete overview of the working area of the compact crane.
	TIP	Never leave a machine unattended with the keys and remote control.
	TIP	Keep the compact crane clean and prevent accumulation of contamination.
	TIP	Follow national regulations concerning working conditions and work safety when using the compact crane.
	TIP	It is recommended that the outriggers be positioned 10 cm above the ground and alongside the machine when driving on a soft or inclined surface to prevent tipping over.
	TIP	It is not possible to fold in the jib when the boom is raised above 45 degrees.

5.3 Emergency stop

There is an emergency stop on the back of the machine and on the remote control. Emergency stop buttons all have the same function: when activated they stop all movements. **Only operate the emergency stop in the event of an emergency or disaster.**

5.4 Emergency operation

	<p>WAARSCHUWING!</p>	<p>Extra caution is required when using the emergency control, because the display screen on the remote control no longer works.</p>
---	-----------------------------	--

- Only use the emergency control if the remote control cannot make radio contact, the display screen is defective or there is no replacement battery available.
- When the emergency control cable is connected, the display screen no longer works!
- Connect the emergency control cable to the connection on the underside of the transmitter and on the electrical cabinet (see figures 5, 6 and 7).
- Operate the transmitter in the usual way, as described in the section 6.2.1.



Figure 5: Emergency control



Figure 6: Emergency control





Figure 7: Emergency control

5.5 Pictograms

The pictograms used are shown below. These may not be removed. Missing or damaged pictograms must be replaced immediately!

Pictogram	Meaning	Location
	<p>Use of safety shoes, gloves and safety helmet is mandatory.</p>	<p>On electrical cabinet</p>

	<p>Lifting point for lifting machine.</p>	<p>On boom</p>
	<p>L to R: Do not use in the vicinity of high voltage cables; Suspended load; It is prohibited to be under the load.</p>	<p>On the crane</p>
	<p>It is prohibited for unauthorised persons to be within the working range or danger zone of the machine.</p>	<p>On the cover of the electrical cabinet</p>
	<p>Check that all safety devices are installed correctly before starting up the machine.</p>	<p>On the cover of the electrical cabinet</p>
	<p>Always consult the user manual before taking any action.</p>	<p>On the cover of the electrical cabinet</p>
	<p>Attention: Raising and lowering outriggers.</p>	<p>On the outriggers</p>
	<p>Attention: When the green lamp is on, the radio remote control for the crane is active.</p>	<p>On crane column next to warning light</p>
	<p>Risk of cutting or severing</p>	<p>On the crane at pivot points and on the outrigger legs at the cylinders</p>

	<p>Electrical danger</p>	<p>On electrical cabinet</p>
	<p>Risk of trapping hands.</p>	<p>On the ballast</p>
	<p>Warning for radio remote control.</p>	<p>On superstructure electrical cabinet</p>

5.6 Stack light

A stack light is fitted on the compact crane. The meaning of the colours is shown below. When bypassed by means of the key switch, the stack light produces an audible signal to warn everyone in the vicinity.















				<p>Crane operation active</p>
				<p>Driving</p>
				<p>Load at 90% to 100%</p>
				<p>Load at 100%</p>
				<p>Bypass 100% to 110%</p>
				<p>Bypass without protection</p>



Figure 8: Stack light

5.7 LML

The following describes how the crane is protected against overload by the LML (Load Moment Limiter). When the crane is standing on the outriggers and the ignition switch is put back in position 2 (crane operation) the crane knows exactly how it is standing on the outriggers. Based on this, the crane knows what it can lift where.

When a load is hanging from the crane and the crane's outreach is increased, if the crane enters the range in which it is no longer allowed to lift the load, it will automatically stop increasing the outreach. The red lamp in the stack light will also light up and an acoustic signal will sound.







Now the crane can only be operated in the direction in which the load comes back into the safe range. That is, the direction in which the outreach is reduced.

The following functions can be blocked by the LML: Extension of main boom and fly jib, winching, raising the main boom and fly jib, rotating the superstructure, retracting the ballast.

6

WORKING WITH THE COMPACT CRANE

Every employee must observe the following rules/warnings while working with the compact crane.

	LEVENSGEVAAR!	Never enter the working area; this can have serious consequences.
	LEVENSGEVAAR!	Do not let unauthorised persons enter the working area of the compact crane.
	LEVENSGEVAAR!	It is prohibited to use the compact crane in an explosion-hazardous area!
	LEVENSGEVAAR!	The user is responsible for safe operation of the crane, the selection of appropriate accessories (based on intended use, capacity, validity of inspection stickers and visual inspection) and the personal safety of the operator and people in the vicinity.
	LEVENSGEVAAR!	Outriggers may only be used on a suitable surface; this means it must be adequately horizontal and have sufficient load bearing capacity.
	LEVENSGEVAAR!	Never use the 110% button to increase the crane's outreach or to continue winching.
	WAARSCHUWING!	Work safely at all times, taking into account the crane, surroundings, ground and load. Do not begin working if there is a plausible risk of a dangerous situation developing before appropriate measures have been taken.

	WAARSCHUWING!	Operate the compact crane with due care; to prevent jolts while driving, never release the levers suddenly. May only be operated by authorised persons!
	WAARSCHUWING!	In the event of a bypass in the electrical cabinet (figure 30, no. 6), sensors will be bypassed. It is prohibited to bypass the winch sensor. Use of the bypass is entirely at your own risk.
	WAARSCHUWING!	Always perform the daily inspection first!
	WAARSCHUWING!	Always ensure that no hazardous situation can develop!
	WAARSCHUWING!	Ensure that the compact crane working area is tidy and cordoned off.
	WAARSCHUWING!	Use an extension cable with a diameter of at least 2.5 mm ² and measuring no more than 25 m in length.
	WAARSCHUWING!	At the end of each working day, plug the charging current plug into the mains socket to charge and balance the battery packs. This keeps the battery packs in a good condition.
	VOORZICHTIG!	Do not use the compact crane until precautions have been considered and taken to safeguard the user, the machine, the load, the surroundings and the ground.
	VOORZICHTIG!	Ensure proper extraction of the exhaust gases when used in enclosed areas.
	VOORZICHTIG!	When it is necessary to perform other related work, switch off the control to prevent unintentional movements.
	VOORZICHTIG!	Never leave the control unattended, unless the ignition key is removed.
	VOORZICHTIG!	Never place loose parts on moving components of the compact crane.
	TIP	The directions of movement of the remote control with respect to the compact crane match best if you are behind the compact crane.



TIP

Use the toolbox only for crane parts and the tools necessary for working with the compact crane (if present).

6.1 Daily inspection prior to use

	<p>LEVENSGEVAAR!</p>	<p>The engine must be stopped when topping off oil, coolant or fuel; DO NOT smoke while performing these tasks.</p>
---	-----------------------------	---

For your own safety and to obtain the maximum service life from your equipment, it is of great importance that you always inspect the condition of the compact crane before use. Resolve any problems you find, or have your dealer do so, before you use the compact crane again.

- Before performing the daily inspection, first ensure that the compact crane is horizontal (to ensure oil level indication is correct).
- Check whether the emergency stop on the remote control is pressed.
- Perform a thorough general visual inspection of the compact crane. Look, in particular, for oil leakage, leaking cylinders, loose connections, dirt accumulation and any damage. Remove any dirt which has accumulated, and have necessary repairs performed if you observe a leak.

- Check the oil level of the hydraulic tank; top up with Hydro 46, if necessary (see *figure 9*).



Figure 9

- Check that all protective caps and covers are in position and that all nuts and bolts are in place and secured firmly.

- Make sure that the pins are present and secure. For example, at the outrigger leg, jib and lifting accessories.

- Visually check the tension and condition of the tracks; if defects are found, contact the dealer.

- The tracks are tensioned by fitting the grease gun to the grease nipple in the centre of the track and pumping to 80 bar (*figure 10*).



Figure 10

- The tracks must be tight.

- Check if the lamps on the sensors for the boom and jib pulse on/off when the extend function is operated. This is how the boom length is measured.

- Check that the crane control levers return to the centre position automatically and that the manual outrigger controls are automatically locked.

- Make sure all loose parts are stored/secured correctly.

- Check the functioning of the emergency stop; never hoist when the emergency stop button is not functioning properly. If defective, always have this repaired immediately!

- Check all rotating and moving parts for wear and damage.

- Check the chains for wear and damage.

- Check for wear of the winch cable, hook and other lifting equipment.

6.2 Controls

6.2.1 Remote control

The compact crane is operated by remote control; the buttons and functions of the remote control are explained in this section.

- The transmitter is splash and rain-proof.
- Never clean the transmitter and receiver with high pressure and do not immerse them.
- Keep transmitter clean; ensure that pictograms, screen and labels remain legible.
- Wear the transmitter on the waist belt around your waist or over the shoulder with a shoulder strap.
- Always keep a second, fully charged transmitter battery at the ready.
- If the transmitter has poor or no contact, switch off the transmitter and the ignition switch of the machine. Switch on again and the transmitter automatically seeks a new frequency.

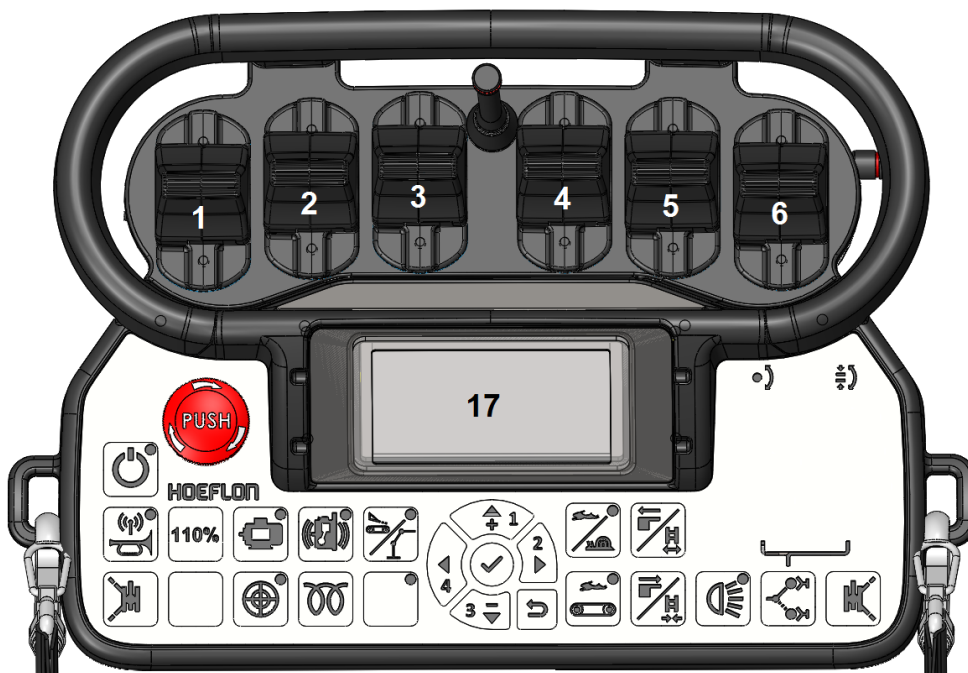









Figure 11











Levers in standard Default						
Key switch in position 1				Key switch in position 2		
Number	Lever	Backwards	Forwards	Lever	Backwards	Forwards
1	LF outrigger	Up	Down	Slewing	Left	Right
2	LR outrigger	Up	Down	Main boom	Retract	Extend

3	L track	Backwards	Forwards	Jib	Retract	Extend
4	R track	Backwards	Forwards	Winch	Lift	Lower
5	RR outrigger	Up	Down	Jib	Extend	Retract
6	RF outrigger	Up	Down	Main boom	Extend	Retract



Figure 12

Buttons			
	Emergency stop	17	Display
	On/off button transmitter		Engage 2nd operating speed
	Activate receiver and horn		Control panel display: ✓ Confirmation button ▲ Up arrow ► Right arrow ▼ Down arrow ◀ Left arrow ↶ Back button
	Release left-side outriggers for swinging. Extend/retract: hold		Release right-side outriggers for swinging. Extend/retract: hold

	while using lever 1 (front outrigger) or 2 (rear outrigger).		while using lever 5 (rear outrigger) or 6 (front outrigger).
	See next page for explanation*		Engage 3rd driving speed (only with pick-and-carry option)
	On/off button electric motor		Tracks (ignition in position 1) extend ballast (ignition in position 2)
	Not used		Tracks (ignition in position 1) retract ballast (ignition in position 2)
	On/off button Yanmar diesel engine		Work light (optional)
	Preheat button Yanmar diesel engine		Not used
	Crane/drive selector (only with pick-and-carry option)		

***110% button**

This button may only be used when the crane is in an unsafe situation. Pressing this button will bring the crane back to a safe situation. The LML is temporarily (30 seconds) increased to 110% when this button is pressed.

Never use to increase the crane's outreach or to continue winching.

6.2.2 Function mapping

This function allows you to assign different functions to the levers. As standard, it is set to **Default**. If you set it to **custom**, then it is set the same as many lorry loader cranes.

- Switch on the remote control and activate the remote control menu by pressing the ✓ button (see figure 13).
- Then open **settings** by pressing the ✓ button and go to **function mapping** with the ▼ button (see figure 14).

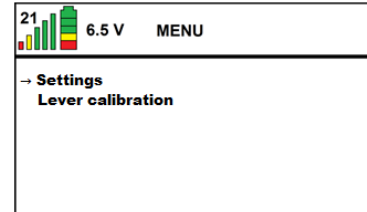

Figure 13

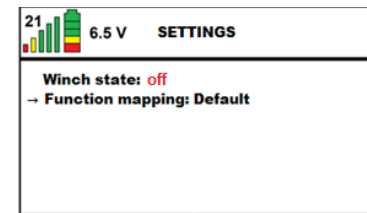

Figure 14

- Now press the ► button to set the function to **custom** (see figure 14).

The table below shows the levers' new functions.

Levers in custom function						
Number	Key switch in position 1			Key switch in position 2		
	Lever	Backwards	Forwards	Lever	Backwards	Forwards
1	LF outrigger	Up	Down	Slewing	Left	Right
2	LR outrigger	Up	Down	Main boom	Extend	Retract
3	L track	Backwards	Forwards	Main boom	Retract	Extend
4	R track	Backwards	Forwards	Jib	Extend	Retract
5	RR outrigger	Up	Down	Jib	Retract	Extend
6	RF outrigger	Up	Down	Winch	Lift	Lower

6.2.3 Calibrating levers

If the levers do not respond over the entire range of movement, they must be calibrated. This is done as follows:

- Switch on the remote control and activate the remote control menu by pressing the ✓ button (see figure 15). Press the ▼ button to move the arrow in the display until it points to 'Lever calibration' (see figure 22).

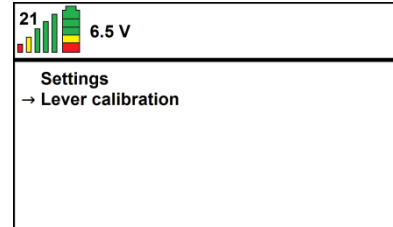

Figure 15

- Press the ✓ button and you will enter the *calibrate levers* screen. You see a bar for each lever. When you operate a lever the bar turns green. In the maximum position the bar should be 100% green. If not, the levers must be calibrated. (see figure 16).

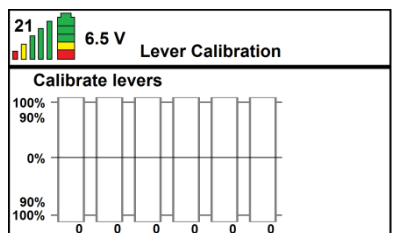

Figure 16

- Press the ✓ button and you will be taken to the next screen. It says *Put levers in center*. Leave all the levers in their centre position; do not operate them (see figure 17).

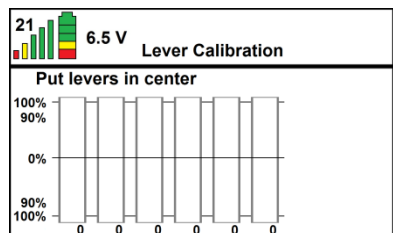

Figure 17

- Press the ✓ button and you will be taken to the next screen. It says *Move levers back and forth*. Slowly operate the levers one at a time, from the maximum backwards position to the maximum forwards position (see figure 18).

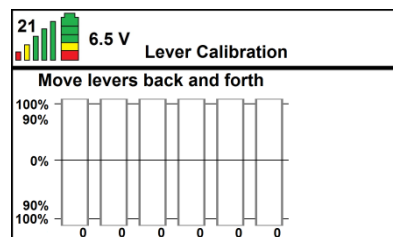

Figure 18

- Press the ✓ button and you will be taken to the next screen. It says *Save calibration*. If you now operate a lever, the bar will turn green again in the direction you have chosen. At the maximum forwards or backwards position, the green bar will fill to 100%. If everything is working properly, press the ✓ button and the settings will be saved (see figure 19).

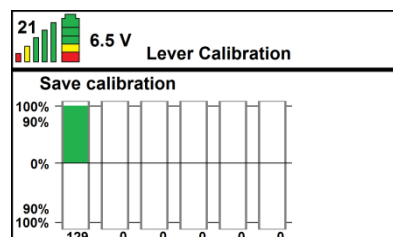

Figure 19

- Pressing ↶ twice will now take you back to the home screen.

6.2.4 Changing transmitter battery

To change the battery in the transmitter, proceed as follows:

- Switch off the transmitter and the machine.
- Remove the battery from the transmitter (*figure 20*).



Figure 20

- Swap the battery in the transmitter with the battery in the battery charger on the crane column (*see figures 21 and 22*). The battery on the crane column will be charged again when the crane is used. Attention! There is a half circle in the plastic on the battery and another on the battery socket. Make sure these are aligned with each other. Otherwise the battery will be backwards.

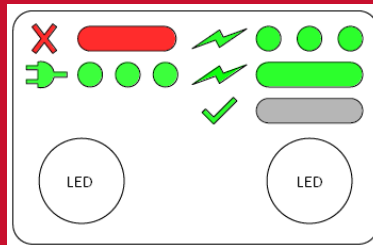

Figure 21

- The machine can be started again.
- See table below for meaning of the LEDs.



Figure 22



Left LED		Right LED	
Battery charger status, for troubleshooting only		Battery status, for user	
LED status	Meaning	LED status	Meaning
Short green flash every 5 s	12V connected	LED off	Battery not connected
LED continuous red	Malfunction	LED continuous green	Battery charging 1 A
		LED flashing green	Charging 0.3 A
		LED off	Battery fully charged

6.2.5 Electrical cabinet



LEVENSGEVAAR!

Remove key from key switch when performing work on the electrical system and prevent unauthorised persons from switching on the machine.

There are a number of functions present on the electrical cabinet. These functions are shown and explained below.

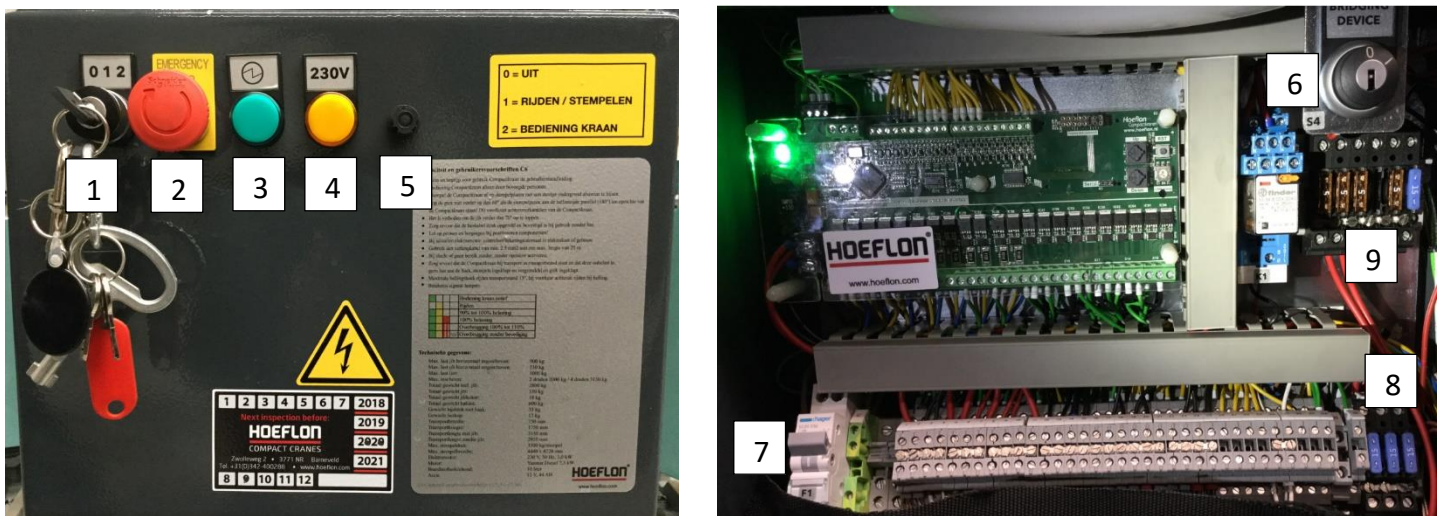

Figure 23

Electrical cabinet		
Number	Component	Function
1	Main switch, implemented as key switch	Left (0): Machine switched off. Centre (1): In this position the drive system and outriggers are active. Right (2): In this position the crane can be operated.
2	Emergency stop	Switches drive off.
3	Power on indicator	Lit when key switch is on.
4	Mains power indicator	Lit when mains power is correctly connected.
5	Connection for emergency control cable	-
6	Key switch	Middle: neutral Right: complete bypass of control functions
7	Main circuit breaker	230V 16A

8	Fuses	15A PCB, controller
		15A Battery charger and sensors
		25A
9	Fuses	5A Gateway
		5A Battery pack 1
		5A Battery pack 2 (option)
		5A Cooling fin (option)
		5A CAN power supply
		15A Valve block

6.2.6 State of charge of battery packs

On the crane column at the left front is a LED indicator bar that shows the charge level of the battery packs. When the packs are fully charged, all the LEDs light up: 4x red, 4x orange and 8x green. As the battery packs become discharged, fewer green LEDs will be lit.

- When the top two green LEDs are flashing, the battery packs are charging.
- If the battery packs are not charged every time the crane is used, the batteries may lose some of their capacity. By always charging them after use, the battery packs maintain their good condition and good capacity.



Figure 24

6.3 Crane operation/control



TIP

Make sure that the crane and the track undercarriage are parallel to one another before collapsing the crane!



TIP

In the event of an overload, retract the extendable sections of the crane or lower the winch cable until the load is once more within the safe operating range of the crane.

6.3.1 Work sequence

To operate the arm of the compact crane, follow these steps in sequence:

- Start the drive system and activate the transmitter as described in section 6.4.
- Check that the outriggers are extended and that the compact crane is level (see section 6.5).
- Check the level of the winch cylinder. Points on the plate must be between the points on the boom (see the yellow circle in *figure 25*). **Contact your dealer or Hoeflon International B.V. if the gauge falls outside the level, in connection with incorrect lifting capacity.**
- Turn the key switch on the electrical cabinet to position 2 (crane).
- Erect the crane by raising the cylinders of boom 1 and the jib in succession, using the corresponding levers on the transmitter (see section 6.2.1). The boom and jib can then be extended. Collapse the crane by performing this procedure in reverse order.



Figure 25

6.3.2 Operation

- Operate the crane with the remote control by moving the levers (see section 6.2.1).
- Do not operate more than one crane function at a time.
- An overload warning will be displayed if the crane reaches its maximum upper position. Lower the mast slightly.

6.3.3 Guiding the load

**WAARSCHUWING!**

The mass, centre of gravity and permissible lift points of the load must be known. The proper crane configuration and lifting accessories can be determined accordingly.

**WAARSCHUWING!**

Always operate the machine extremely carefully, and with a load only in the first operating speed. Avoid abrupt movements and maintain contact with any assistants helping to guide the load.

Adhere to the following rules when guiding a load:

- Never place body parts (feet, legs, hands) under the load.
- During horizontal guiding of the load, follow behind the load.
- Never place body parts between the load and obstacles in the surrounding area, and never go between the load and an obstacle without a safe amount of space between them.
- When working near or with fragile material (e.g. stone, glass) where there is a risk of splinters/shards, wear protective clothing and safety glasses.
- Maintain visual contact and open channels of communication between guides and operator.
- When working with tall, unstable loads, never stand in the fall direction of the load.
- Whenever possible, use guide lines to maintain a safe distance.
- When using guide lines for a load at height, never walk under the load and maintain a safe distance, taking into account influence of the fall direction of the load due to obstacles in the environment.
- Make sure you always have an open escape route where you can flee for safety.
- Never stand or hang on the load.
- Make sure the load is properly secured and is and will continue to hang stable.
- Avoid abrupt movements of the machine and load.
- Operate the machine with load only in the slow operating speed.
- When using guide lines, clear the surrounding areas to eliminate the risk of tripping and the risk that the guide line will get caught and/or damaged.

6.4 Driving the compact crane.

	LEVENSGEVAAR!	It is forbidden to drive with the ballast extended, as this creates a risk that the compact crane will tip over backwards.										
	LEVENSGEVAAR!	<p>Machine will tip over if exceeded!</p> <table border="0"> <tr> <td>On slopes:</td> <td>Maximum slope angle</td> </tr> <tr> <td>Forwards</td> <td>15°</td> </tr> <tr> <td>Backwards</td> <td>23°</td> </tr> <tr> <td>Sideways</td> <td>Retracted tracks: 15°</td> </tr> <tr> <td></td> <td>Extended tracks: 23°</td> </tr> </table>	On slopes:	Maximum slope angle	Forwards	15°	Backwards	23°	Sideways	Retracted tracks: 15°		Extended tracks: 23°
On slopes:	Maximum slope angle											
Forwards	15°											
Backwards	23°											
Sideways	Retracted tracks: 15°											
	Extended tracks: 23°											
	LEVENSGEVAAR!	It is forbidden to be beside the compact crane while driving. This is due to the risk of instability.										
	WAARSCHUWING!	Operate the compact crane with due care; to prevent jolts while driving, never release the levers suddenly. May only be operated by authorised persons!										
	WAARSCHUWING!	It is forbidden to drive through water more than 10 cm deep.										
	WAARSCHUWING!	Always drive with the tracks extended; this minimises the load on the ground and provides the machine with maximum stability.										
	WAARSCHUWING!	If the situation necessitates that the tracks be retracted, always use the first driving speed. Be extra cautious.										
	WAARSCHUWING!	<p>It is forbidden to pull with boom and jib, both horizontally and vertically, such as pulling out poles or dragging loads. The crane is intended for vertical transport of loads subjected only to the pull of gravity.</p> <p>Dragging loads from the pulling eye is allowed while driving.</p>										
	TIP	When driving on a steep slope, it is advisable to keep the outrigger legs on the downhill side 10 cm above the ground. If the compact crane tips, it will be caught by the outrigger legs and will not tip over completely.										

6.4.1 Sequence of operations for starting crane





- Ensure that all the control levers are in the '0' position.
- Ensure that the crane is collapsed and unloaded.
- Turn the key switch on the electrical cabinet to position 1 (see *figure 12*).
- Switch on the transmitter (button )
- Activate the transmitter by pressing button 
- Operate levers 3 and 4 on the transmitter at the same time to drive in the direction indicated by the arrow, and operate just one lever to steer.
- The driving direction is indicated by the arrow in *figure 26*.





Figure 26

- Stop the compact crane by releasing the levers; they return to the centre position automatically.
- At the end of the day, plug the charging current plug into the mains socket to keep the battery packs in good condition.

6.4.2 Crawler track width adjustment

	WAARSCHUWING!	Make sure the compact crane is standing on the outriggers so that the crawler tracks are able to move freely.
	WAARSCHUWING!	Avoid contact with the outrigger legs due to risk of entrapment!

- First raise the crane on the outriggers.
- Press the  button on the transmitter (*figure 39*) to extend the tracks.
- Press the  button on the transmitter (*figure 39*) to retract the tracks.
- Use only the maximum and minimum settings when configuring the crawler track width.







6.4.3 Transport position

The compact crane must be put in the transport position for driving. To do this, follow these steps:

- Be careful when lowering the boom to the transport position that the boom and jib do not contact the motor shroud and toolbox at the front and that the jib does not contact the toolbox if the jib is hanging beside the boom.
- The jib adapter can be attached to the jib if the jib is hanging beside the boom and other attachments are desired.

- Secure attachments in the intended locations during transport. 30 degree section and winch head alongside the boom, manual jib extension on the ballast, jib adapter in the boom.
- Make sure that in the transport position the winch is always rolled up and the attachments are stowed and secured.

6.5 Use of the outriggers

	WAARSCHUWING!	To prevent contact between the ballast and outrigger legs during slewing make sure that the outrigger legs are not extended too far, e.g. one outrigger placed on an elevation.
	WAARSCHUWING!	Make sure the outrigger leg is horizontal, with a maximum tilt of 5°, to prevent instability.
	WAARSCHUWING!	Do not raise the compact crane higher on the outriggers than necessary; once the tracks have been lifted off the ground it is high enough.
	WAARSCHUWING!	Assess the ground condition and use outrigger pads to reduce the ground pressure.
	VOORZICHTIG!	Make sure the outrigger foot sits in the recessed circle on the outrigger pad when setting the outriggers. This is particularly important when raising the machine high on the outriggers, in connection with the folding legs.
	VOORZICHTIG!	Check that the crane is retracted.

6.5.1 Work sequence

	<p>LEVENSGEVAAR!</p>	<p>Outriggers may only be used on a suitable surface; this means it must be horizontal and have sufficient load bearing capacity.</p>
	<p>WAARSCHUWING!</p>	<p>Maintain a close watch on the active outrigger leg during extension to prevent foot entrapment.</p>

Preparation

- Make sure the ground has sufficient load bearing capacity.
- Position the machine in the ideal position; consider safety, obstacles within slewing range, horizontal outreach of the load, capacity and limits of the crane and ground.
- If the crane is raised on the outriggers in the vicinity of a ditch or slope, it is recommended that distance A from the outrigger to the edge be at least twice as long as depth B of the ditch (see figure 27).
- Make sure that people who must be within the working area of the crane can work there safely, by giving them instructions and showing them safe escape routes.
- To operate the outriggers, the boom angle must be less than 40 degrees and the ballast must be retracted.

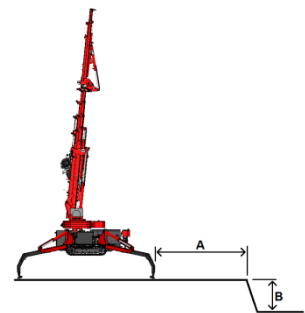

Figure 27

Execution

- Switch on the machine with the key switch of the machine in position 1, for the drive and outrigger functions.
- Switch on and activate the remote control.
- Set the outrigger angle of each outrigger leg, preferably to 48.5 degrees for 100% outrigger leg range.
- Check the outrigger angle on the display of the remote control.
- Operate the outriggers one at a time and lower them until they are horizontal so the outriggers can be more easily extended. Maintain a clear view of the operated outrigger.
- Adjust the outrigger length by extending the outriggers. If they are extended manually, they can only be extended completely. If they are extended hydraulically, you can choose how far to extend them (preferably all the way, for 100% outrigger range).
- Check the outrigger length on the display of the remote control.
- Operate the outriggers one at a time and lower the outrigger legs until they are just above the ground. Maintain a clear view of the operated outrigger.
- Place the outrigger pads under the outrigger feet so the outrigger foot falls in the recess of the outrigger pad. Also check the ground in the immediate vicinity for unevenness, loose material, slope and other issues that can affect the stability.
- Operate the outrigger legs one at a time and lower them onto the outrigger pads.
- Now operate the outriggers at the front simultaneously so the machine is just lifted off the ground; do the same with the rear outrigger legs.
- Check whether the machine is level and correct if necessary. The bubble in the level must be in the middle of the circle.
- Check whether all the outriggers are in contact with the ground and correct if necessary.

- Turn the key switch to position 2 once the machine is standing firmly on the outriggers; the outrigger configuration is now set and is saved.

Check

- Check the outrigger angle and length on the remote control display.
- Check whether the crane is standing level (see *figure 28*) after the outriggers have been set.
- Check whether all the outriggers are in contact with the ground after they have been set. (See also section 6.5.4, green dot).



Figure 28

6.5.2 Operation

Mechanical

- Release the outrigger legs by operating the lever so that the outrigger legs can be rotated by hand (see *figure 29*).
- Turn the outrigger legs so that they are positioned at a 45° angle to the machine and then release the lever. The lever will spring back to its released position automatically when it is in the correct position.
- Release and pull out the extendable section until you reach the end of the mark, i.e. the white stripe (see *figure 30*), and then lock into position.

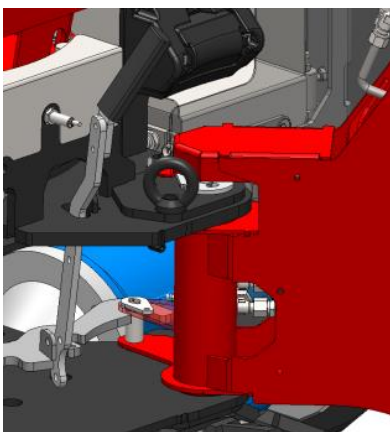

Figure 29

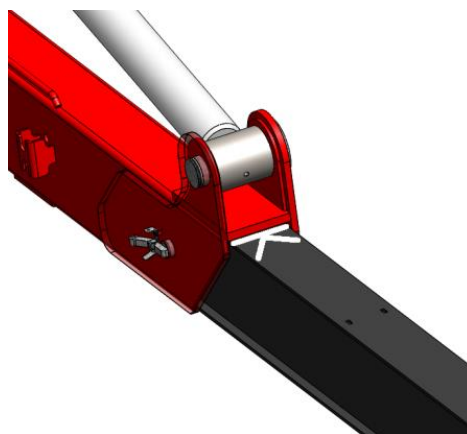







Figure 30

Hydraulic



WAARSCHUWING!

Hydraulic extension is only possible if all the outriggers are lifted off of the ground. Otherwise the extension system will be damaged.

- Turn the key switch (1) on the electrical cabinet to the 'outrigger operation/driving' position.
- Start the drive system and switch on the transmitter as described in the section 6.4.
- Release the stabiliser legs using buttons  and  on the transmitter, so that the stabiliser leg can be manually rotated through a 90° angle. The compact crane factors in the position of the outrigger legs when calculating the load.
- Turn the outrigger legs to the required position and release the button. The outrigger leg will be locked in place.
- Extend the outriggers of the compact crane until the outrigger legs are horizontal by pushing forward levers 1, 2, 5 and 6 on the transmitter one at a time.
- Release and pull out the extendable section until you reach the end of the mark, i.e. the white stripe (see figure 42), and then lock into position.
For hydraulic extension. Operate the following buttons on the remote control: button  along with levers 1 and 2 for left, and button  along with levers 5 and 6 for right.
- Position the four outrigger legs of the compact crane so that the outriggers are level, using rig mats or outrigger pads.

6.5.3 Nodding outrigger legs option.

Nodding outrigger leg

- The nodding outrigger leg option is operated by removing the locking pin from the nodding tube (see figure 31).
- Then the nodding section is manually pulled out all the way to the end stop (see figure 32).
- Next the nodding section can be lowered (see figure 33).
- Now the locking pin must be fitted again (see figure 34).



Figure 31

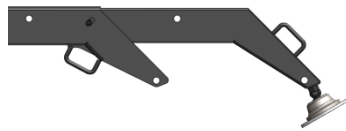

Figure 32



Figure 34

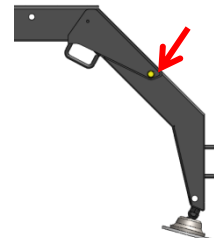

Figure 33

6.5.4 Interpreting the display while setting the outriggers

While the outriggers are being set, info about how much may be lifted and how the crane is positioned is shown on the display of the remote control. This is explained below.

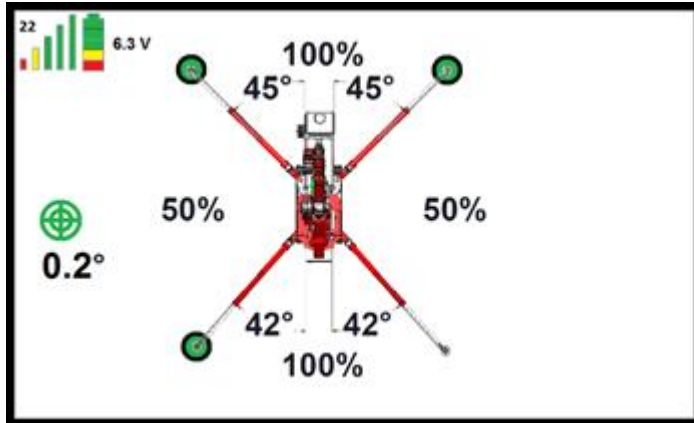

Figure 35

- The transmission frequency is shown at the top left. See *figure 35*; here it is set to 22.
- The signal strength is indicated by 5 vertical bars. If the strength is good, they are all shown, as in *figure 35*. As the signal weakens, the green bars disappear first, then the yellow and red ones. If the signal is too weak, you can select another frequency by switching the transmitter and machine off and on again. See section 6.2.1.
- The battery state of charge is shown in the battery symbol in the top-left corner of the screen. When the battery is fully charged, 3 green blocks, 1 yellow and 1 red are shown, as in *figure 38*. As the battery discharges, the blocks go out, one at a time.
- The voltage is shown in volts. In *figure 38* this is 6.3 V.
- The degree of levelling of the machine is also shown. This is indicated by the green circles in the middle. In *figure 35* the crane is 0.2° out of level. Which side it is leaning towards is not shown. This can be seen on the level (see *figure 28*).
- The left-front outrigger leg is set at 45° in *figure 35*.
- The right-front outrigger leg is set at 45° in *figure 35*.
- The left-rear outrigger leg is set at 42° in *figure 35*.
- The right-rear outrigger leg is set at 42° in *figure 35*.
- At the front of the crane 100% of the lifting capacity may be lifted in *figure 35*.
- On the right side of the crane 50% of the lifting capacity may be lifted in *figure 35*.
- At the rear of the crane 100% of the lifting capacity may be lifted in *figure 35*.
- On the left side of the crane 50% of the lifting capacity may be lifted in *figure 35*.
- A green circle is shown by three of the four outrigger legs in *figure 35*. The outrigger leg without a circle is not set properly; it is most likely not in contact with the ground or there is too little pressure on it. When a green circle appears, it is set properly.

6.6 Attachment/Removal

6.6.1 Jib

Removing the jib:

- Position the boom and jib as shown in *figure 36*. Make sure the boom is positioned slightly above horizontal. This makes the jib easier to turn.
- Remove the two pins from the left-hand side of the hinged section of the jib (see *figure 37*).
- Rotate the jib 180° (see *figure 38*).
- Secure the D-shackle on the main boom to the eye on the jib (*figure 39*). Raise the jib when you do this, until it can be secured in the D-shackle. Secure the D-shackle (see *figure 40*).
- The jib is now suspended in the D-shackle and can be moved easily



Figure 36



Figure 37



Figure 38

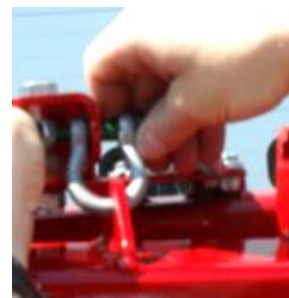

Figure 39

- Remove the two pins from the right-hand side of the hinged section of the jib. Lower the jib when you do this so that it is easier to remove the pins.



Figure 40

- With the axle on the underside of the boom, guide the jib into the appropriate section of the main boom (figure 41) and secure in position (figure 42).



Figure 42



Figure 41

- Secure the handle on the hook on the jib and lock into place (figure 43).



Figure 43

- Remove the hydraulic hoses (figure 44) and the power plug (figure 45). Secure the loose hoses to the jib.



Figure 44



Figure 45

- The fixed section of the jib can be removed from the boom, if necessary, by removing the pin (figure 46) and manually pulling the section out of the main boom (figure 47). It is also possible to work with the compact crane if the fixed section of the jib is still in the boom.









Figure 46

- To install the jib, perform the steps in reverse order.
- Do not forget to secure the pins!



Figure 47

6.7 Winch operation/control

	LEVENSGEVAAR!	Max. winch load is 1000 kg, or 2000 kg with single reeving or, for type C6, 3000 kg with double reeving. Where a reeved cable is used, it is prohibited to lift if the winch cables are twisted. Otherwise the cable may break.
	LEVENSGEVAAR!	Make sure the cable runs through the grooves in the cable sheaves and the slot in the winch head stop plate!
	LEVENSGEVAAR!	Make sure the winch cable does not have any damage, wear, twists or kinks. If it does, replace the cable before using the crane.
	WAARSCHUWING!	The winch may only be used for vertical lifting; if lifted at an angle there is a risk of overload.
	WAARSCHUWING!	As far as possible, leave the winch weight on the cable so that it will roll up tighter.
	WAARSCHUWING!	The winch will stop automatically when there are 3 turns of steel cable remaining on the winch drum.

- For the correct selection of attachments and swivel hooks, see the table in sections 6.7.4, 6.7.5 and 6.7.6. Other use is prohibited.
- Reeve the winch cable if the mass of the load exceeds the capacity of the winch. Use one sheave in the winch weight for single reeving (2 cables) and two sheaves in the winch weight for double reeving (4 cables). For reeving, see section 5.7.5.
- The winch cable may get stuck under the ballast tube with the boom at 85 degrees; this risk can be eliminated by extending the ballast.
- Make sure that both pins are attached and secured when using the winch head in the 30 degree section.
- Push the winch weight backwards when lifting the winch weight off of the motor shroud support. Be careful that the winch weight does not get caught on the support.
- When removing the winch weight be careful that the elastic strap that holds the lifting hook has been removed.
- When configuring the winch weight for reeving, be careful to remove the centring bush for the lifting hook while switching from two sheaves to one or to no sheave. It should only be used when two sheaves are used in the winch weight.
- Any time tension has been removed from the winch cable, check that the winch cable is still taught and neatly wound around the winch drum before operating the winch.
- When using the winch, keep in mind the limits of the various machine configurations.

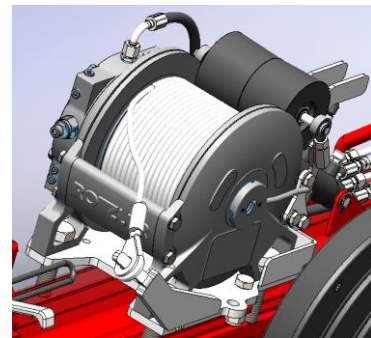

Figure 48: Winch

- Remember: the complete winch weight is 33 kg. It is not intended to be lifted or moved by hand.
- With the exception of the winch weight, lifting hook and the ballast removal support, it may not be used to pull on the machine.

6.7.1 Order of operations without options

Check

- Check that the winch plate is within the indicator range. The winch plate must not be crooked. **When under tension, the winch plate must be between the indicator points (see figure 49).**
- Check the cylinder behind the winch for leakage.
- Visually inspect the winch cable for external deficiencies, such as kinks and broken strands.
- Check that the winch cable is taught and neatly wound around the winch drum. If not, unwind it and roll it up neatly (see figure 50). Always use a weight when rolling up.



Figure 49



Figure 50

Preparation

- Make sure the machine is supported on the outriggers, with the tracks just above the ground.
- Make sure the jib, jib adapter and/or other attachments have been removed from the boom and stored and secured in place.
- Make sure the boom is horizontal and retracted.

Attachment of winch head

- Remove the winch head from the boom support (see figure 51).



Figure 51

- Secure the boom adapter to the rear of the winch head with the locking pin. Secure the pin (see figure 52).



Figure 52

- Connect the winch head with the boom adapter to the boom with the locking pin. Secure the pin (see figure 53).



Figure 53

Activating winch operation

- Activate the winch control by pressing the ✓ button on the remote control (see figure 54).

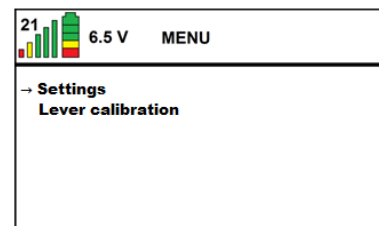

Figure 54

- Now open **settings** by pressing the ✓ button. Then move the arrow to select **winch state** with the ▼ button. Then use the ► button to set **winch state** to **ON** (see figure 55).

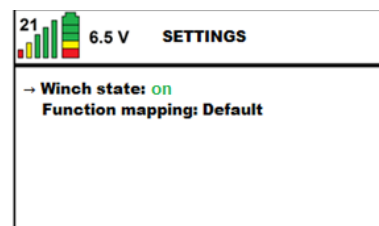

Figure 55

- After activating and setting the winch, return to the main display by pressing the ↵ button.

Execution

- Start the drive system and activate the transmitter as described in section 6.4.
- Check that the outriggers are extended and that the compact crane is level (see section 6.5).
- Check whether the winch plate is between the indicator points. **If not, contact your dealer or Hoeflon International B.V.**
- Turn the key switch (1) on the electrical cabinet to position 2 'crane' (see figure 23).
- Erect the crane by raising the cylinder of boom 1, using the corresponding levers on the transmitter (see section 6.2.1). The boom can then be extended. Roll out the winch cable as described below.

Fitting winch cable



WAARSCHUWING!

The use of gloves is mandatory when attaching the winch cable!

- Use one hand to operate the joystick for the winch and use the other hand to hold the winch cable and keep it under tension.
- Roll out the winch cable until approximately one metre in front of the machine. Keep the winch cable under tension while rolling it out.
- Switch off the remote control.
- Run the winch cable over the winch cable sheaves of the boom as shown in the figures. Check that the winch cable has been run over the winch sheaves correctly (see figure 56). There is an arrow engraved in the side of each winch sheave. These indicate how the cable is to be routed.



Figure 56

- Run the winch cable over the winch head. First remove the upper pin in the winch head. For lifting with one cable, place the winch cable over the centre winch cable sheave and fit and secure the upper pin in place again. Position the cable correctly through the winch weight stopper (see figures 57 and 58).



Figure 57

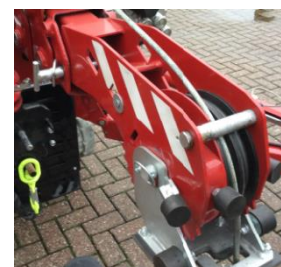

Figure 58

Rolling up winch cable

- When rolling up the winch cable after you are finished using the winch, roll up the winch cable until approximately one metre in front of the machine, then guide it off of the winch cable sheaves, then pull the cable taught and roll it up (see figure 59).
- Hang the eye around the support and carefully roll up the winch cable and gently pull it tight.

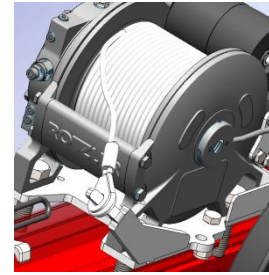

Figure 59

- Deactivate the winch by setting the **Winch state** to **OFF** in the remote control menu(see figure 60).

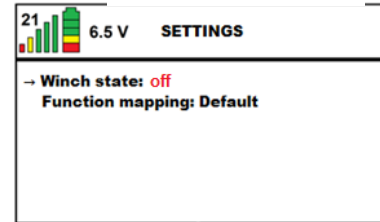

Figure 60

6.7.2 Order of operations for use with jib

Preparation

- Make sure the machine is supported on the outriggers, with the tracks just above the ground.
- Make sure the jib is correctly attached to the boom, as described for use of the jib (see section 6.6.1).
- Make sure the attachments have been removed from the jib and stored and secured in place.
- Make sure the boom and jib are horizontal and retracted,

Mounting winch head and attaching winch cable

- Remove the winch head from the support on the boom, and mount the winch head to the jib with the locking pin. Secure the pin.
- Use one hand to operate the joystick for the winch and use the other hand to hold the winch cable and keep it under tension. Roll out the winch cable until approximately one metre in front of the machine. Keep the winch cable under tension while rolling it out.
- Run the winch cable over the winch cable sheaves of the jib as shown in the figures. Check that the winch cable has been run over the winch sheaves correctly. Refit the retainers.
- Run the winch cable over the winch head and attach the winch weight as described under ‘basic use of winch’ (see section 6.7.7).

Check

- Make sure all the pins and loose parts are properly attached and secured.
- Make sure the winch cable does not get caught on the jib and jib structure.

When the jib is installed:

- Slide the cable through the opening between the two cable rollers (see figure 61). Now release the cable between the two rollers. Insert the eye through the recessed support. Now place the cable in the cable roller by holding the cable in the upper notch and sliding the roller under it. Now the cable can drop into the roller, and the roller with cable can be slid back into the middle.



Figure 61

- Pass the cable through the plastic slot, so that it runs through the hole (see figure 62)



Figure 62

- Pull the cable over the winch head (see figure 63) and follow the steps described above.
- To remove the winch cable, perform the steps in reverse order. Make sure that the winch cable is rolled tightly by holding the cable firmly while rolling.



Figure 63

- After removing the winch, connect the hook to a D-shackle if required (see figure 64). Insert the pin and lock in position.
- For operation of the crane and winch, see sections 6.3 and 6.5.

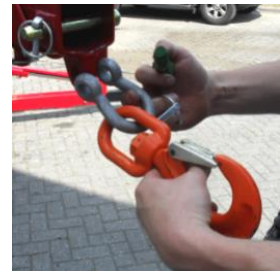

Figure 64

6.7.3 Order of operations winch head and manual jib extension plus additional 30 degree adjustable section

Preparation

- Make sure the machine is supported on the outriggers, with the tracks just above the ground.
- Make sure the jib is correctly attached to the boom, as described for use of the jib.
- Make sure the attachments have been removed from the boom or jib and stored and secured in place.
- Make sure the boom and/or jib are horizontal and retracted,

Attaching 30 degree adjustable section

- Remove the 30 degree adjustable section from the boom; fit the retainer back in place. If it will be used in the boom, mount the boom adapter.
- Mount the 30 degree adjustable section to the boom or jib and lock it with the locking pin. Secure the pin.

Attaching manual jib extension

- Remove the manual jib extension (*figure 65*) from the ballast.
- Place the manual jib extension in the jib tube and lock it with the pin.
- Or place the boom adapter so the manual jib extension can be placed directly in the boom and lock it with the locking pin.

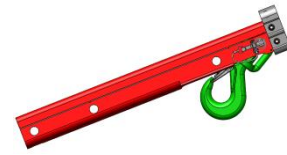
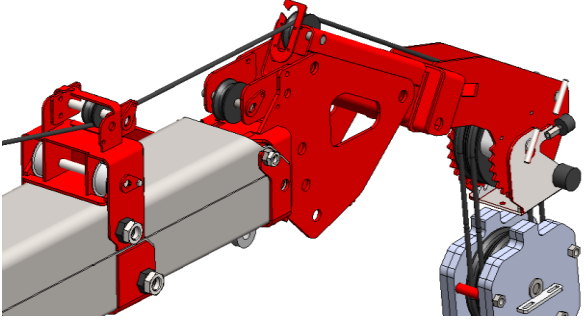
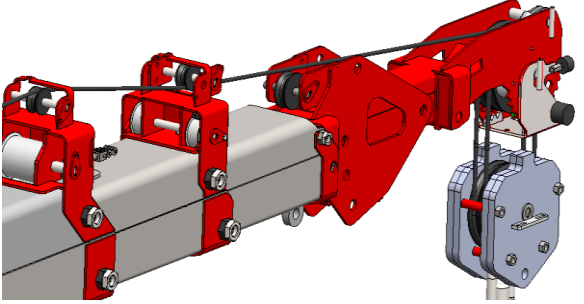
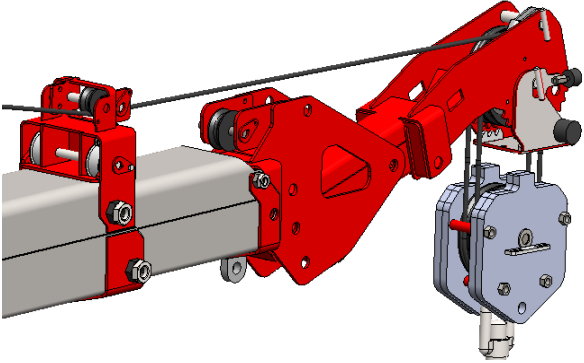
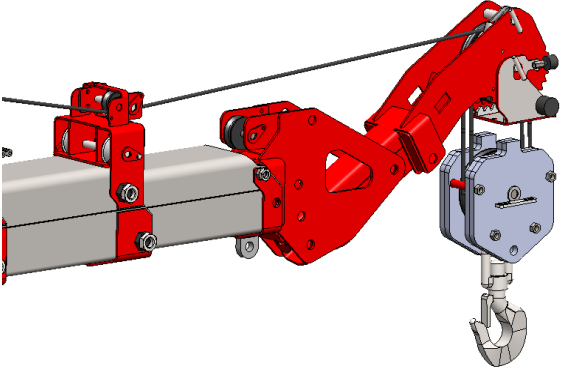

Figure 65

Attaching manual jib extension along with 30 degree adjustable section

- Attach the manual jib extension to the 30 degree section with the two pins and secure them.

6.7.4 Positions of winch head in 30° section when used with main boom

Main boom	
<p>Winch head in top hole.</p> <p>See the adjacent figure for the cable routing.</p> <p>Cable over auxiliary pulley to rear of winch head.</p>	
<p>Winch head in 2nd hole.</p> <p>See the adjacent figure for the cable routing.</p> <p>Cable without auxiliary pulley to large cable sheave in winch head.</p>	
<p>Winch head in 3rd hole.</p> <p>See the adjacent figure for the cable routing.</p> <p>Cable without auxiliary pulley to large cable sheave in winch head.</p>	
<p>Winch head in bottom hole.</p> <p>See the adjacent figure for the cable routing.</p> <p>Cable without auxiliary pulley to large cable sheave in winch head.</p>	

6.7.5 Positions of winch head in 30° section when used with jib

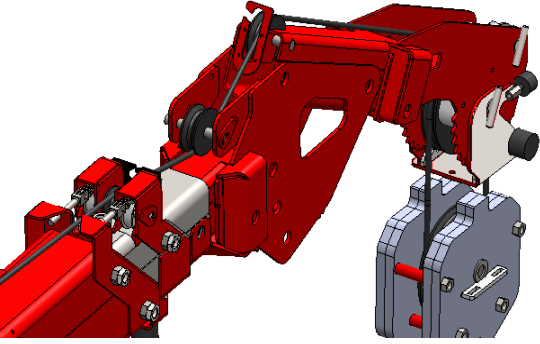
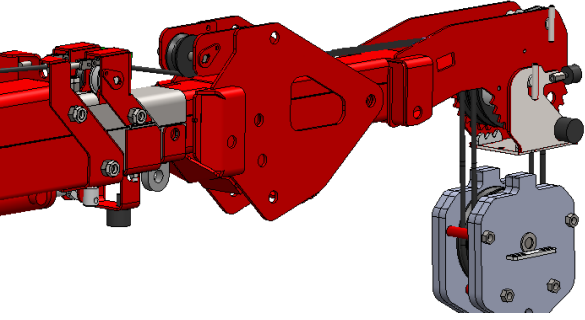
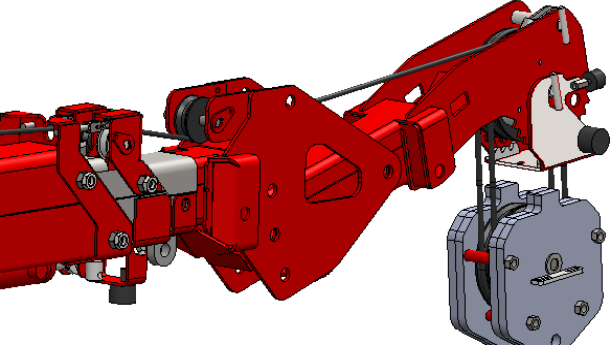
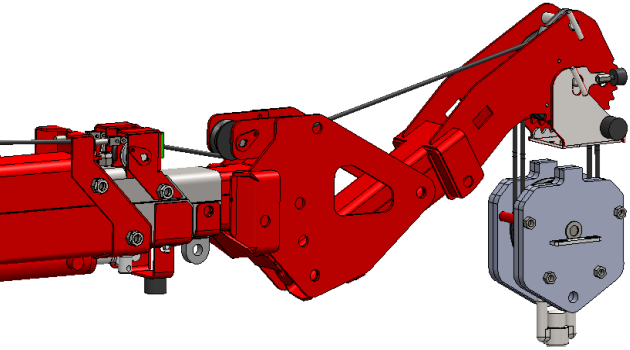
Jib	
<p>Winch head in top hole.</p> <p>See the adjacent figure for the cable routing.</p> <p>Cable under auxiliary pulley of the 30° section and over auxiliary pulley at rear of winch head, to large cable sheave in winch head.</p>	
<p>Winch head in 2rd hole.</p> <p>See the adjacent figure for the cable routing.</p> <p>Cable under auxiliary pulley of the 30° section through to large cable sheave in winch head.</p>	
<p>Winch head in 3rd hole.</p> <p>See the adjacent figure for the cable routing.</p> <p>Cable under auxiliary pulley of the 30° section through to large cable sheave in winch head.</p>	
<p>Winch head in bottom hole.</p> <p>See the adjacent figure for the cable routing.</p> <p>Cable under auxiliary pulley of the 30° section through to large cable sheave in winch head.</p>	

6.7.6 Limits

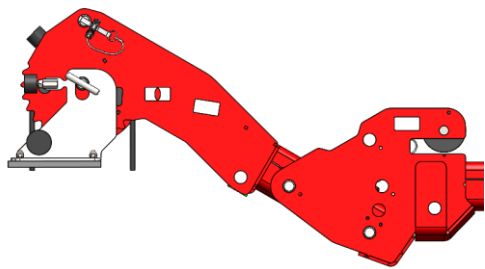

Figure 66: 30 degree adjustable section raised

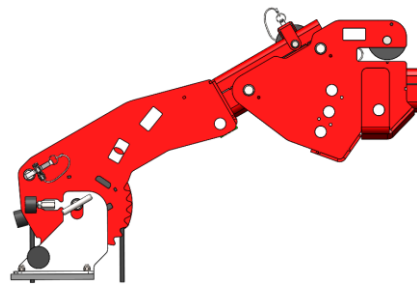
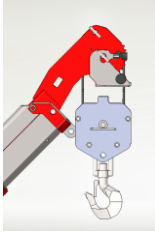
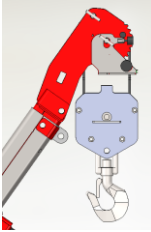
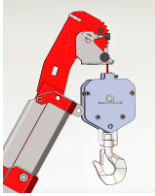
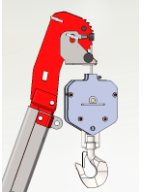
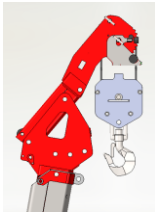
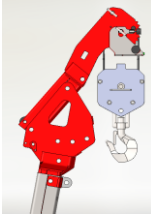
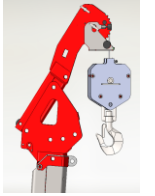
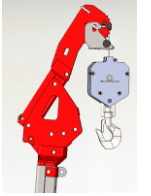





Figure 67: 30 degree adjustable section lowered

		USE WITHOUT JIB		USE WITH JIB	
	Number of reevings	Min. boom angle	Max. boom angle	Min. jib angle	Max. jib angle
Winch head without lifting weight		Not permitted	Not permitted	Not permitted	Not permitted
Winch head	0	0 degrees	70 degrees	-70 degrees	70 degrees
	1 or 2	0 degrees	45 degrees	-70 degrees	45 degrees
30 degree adjustable section with winch head lowered (see Fout! Verwijzingsbron niet gevonden. 67).	0	0 degrees	85 degrees	-40 degrees	70 degrees
	1 or 2	0 degrees,	85 degrees, 80 degrees with retracted boom	-70 degrees	60 degrees
30 degree adjustable section with winch head raised (see Fout! Verwijzingsbron niet gevonden. 66).	0	0 degrees	60 degrees	-70 degrees	60 degrees
	1 or 2	0 degrees	35 degrees	-70 degrees	35 degrees

Maximum angles.

Winch head positions	Maximum possible angle of main boom from horizontal	Illustrations main boom max. position	Maximum possible angle of jib from horizontal	Illustrations jib max. position
Winch head with lifting weight reeved	$\leq 45^\circ$		$\leq 55^\circ$	
Winch head with lifting weight and single cable	$\leq 60^\circ$		$\leq 70^\circ$	
Winch head with 30° section in upper hole with lifting weight reeved	$\leq 80^\circ$		$\leq 80^\circ$	
Winch head with 30° section in upper hole with lifting weight and single cable	$\leq 85^\circ$		$\leq 85^\circ$	

6.7.7 Attaching winch weight

	<p>LEVENSGEVAAR!</p>	<p>Max. winch load is 1000 kg, or 2000 kg with single reeving or, for type C6, 3000 kg with double reeving. Where a reeved cable is used, it is prohibited to lift if the winch cables are twisted.</p>
	<p>LEVENSGEVAAR!</p>	<p>Make sure the cable runs through the grooves in the cable sheaves and the slot in the winch head stop plate!</p>
	<p>WAARSCHUWING!</p>	<p>The winch will stop automatically when there are 3 turns of steel cable remaining on the winch drum.</p>

Preparation

- Make sure the machine is supported on the outriggers, with the tracks just above the ground.
- Make sure the winch head is mounted as described (see section 5.7.1).

Mounting winch weight without reeving

- Remove the split pin from the winch weight.
- Take off the front half of the winch weight.
- Remove the two cable sheaves.
- Remove the lifting hook with the centring bush.
- Refit the lifting hook without the centring bush.
- Attach the winch cable eye to the shaft on which the cable sheaves were fitted.
- Fit the front half of the winch weight back in position. Note: the front half must be turned around before it is put in place again. It will now slide the rest of the way over the strips, and the eye of the winch cable will fit nicely in between.
- Fit the split pin in the 2nd hole in front of the front section of the winch weight so it is secured in place.

Attaching winch weight with single reeving

- Remove the split pin from the winch weight.
- Take off the front half of the winch weight.
- Remove one cable sheave.
- Remove the lifting hook with the centring bush.
- Refit the lifting hook without the centring bush.
- Attach the winch cable to the cable roller.
- Fit the front half of the winch weight back in position. Note: the front half must be turned around before it is put in place again. It will now slide the rest of the way over the strips and almost contact the cable roller.
- Fit the split pin in the 2nd hole in front of the front section of the winch weight so it is secured in place.
- Pull the cable eye of the winch cable along the inside of the winch head and place it over the black plastic with the hole in it. Remove the pin at the top of the winch head and fit it again with the pin through the cable eye.

Attaching winch weight with double reeving

- Remove the split pin from the winch weight.
- Take off the front half of the winch weight.
- Lead the winch cable around one cable sheave and then around the outermost cable roller of the winch head. Then around the 2nd cable roller of the lifting weight.
- Make sure the lifting hook is around the centring bush.
- Fit the front half of the winch weight back in position. Make sure it is placed such that the cable rollers can turn freely. If it is mounted incorrectly, the cable sheaves will rub against the steel weight.
- Fit the split pin in the 1st hole in front of the front section of the winch weight so it is secured in place.
- Pull the cable eye of the winch cable along the inside of the winch head and place it over the black plastic with the hole in it. Remove the pin at the top of the winch head and fit it again with the pin through the cable eye.

Check

- Make sure all the pins and loose parts are properly attached and secured.
- Make sure the winch cable does not get caught on the jib and jib structure.

Execution

- Switch on the remote control and position the winch cable above the winch weight by raising the boom, slewing it if necessary and rolling out the winch cable. Use one hand to operate the joystick for the winch and use the other hand to hold the winch cable and keep it under tension.
- Remove the pin from the removable half of the winch weight and remove this half (see figure 68).



Figure 68



Figure 69

- Fit the required number of cable sheaves. For no reeving do not use any sheaves. Attach the eye to the shaft that the sheaves were on (see figure 69).

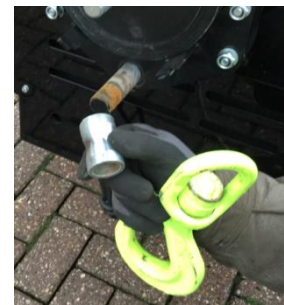

Figure 70

- Position the lifting hook and the winch cable, fit the removable half of the winch weight back in place and secure it in place (see figure 70).
- Attach the loop of the winch cable to the winch head. The cable must enter the hole in the plastic from the inside of the winch head, and then the pin can go through the eye of the winch cable. Secure the pin (see figure 71).
- Use one hand to operate the joystick for the winch and use the other hand to hold the winch cable and keep it under tension. Pull the winch cable until it is under tension.
- Use one hand to push the winch weight backwards so it is no longer secured and use the other hand to operate the joystick for the winch. See whether the winch weight can be lifted free of the support, and lift the winch weight off of the support.

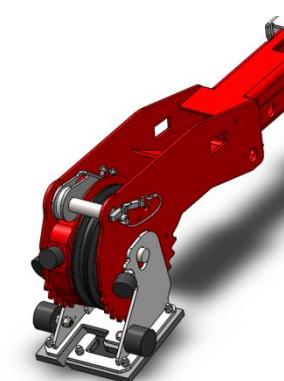
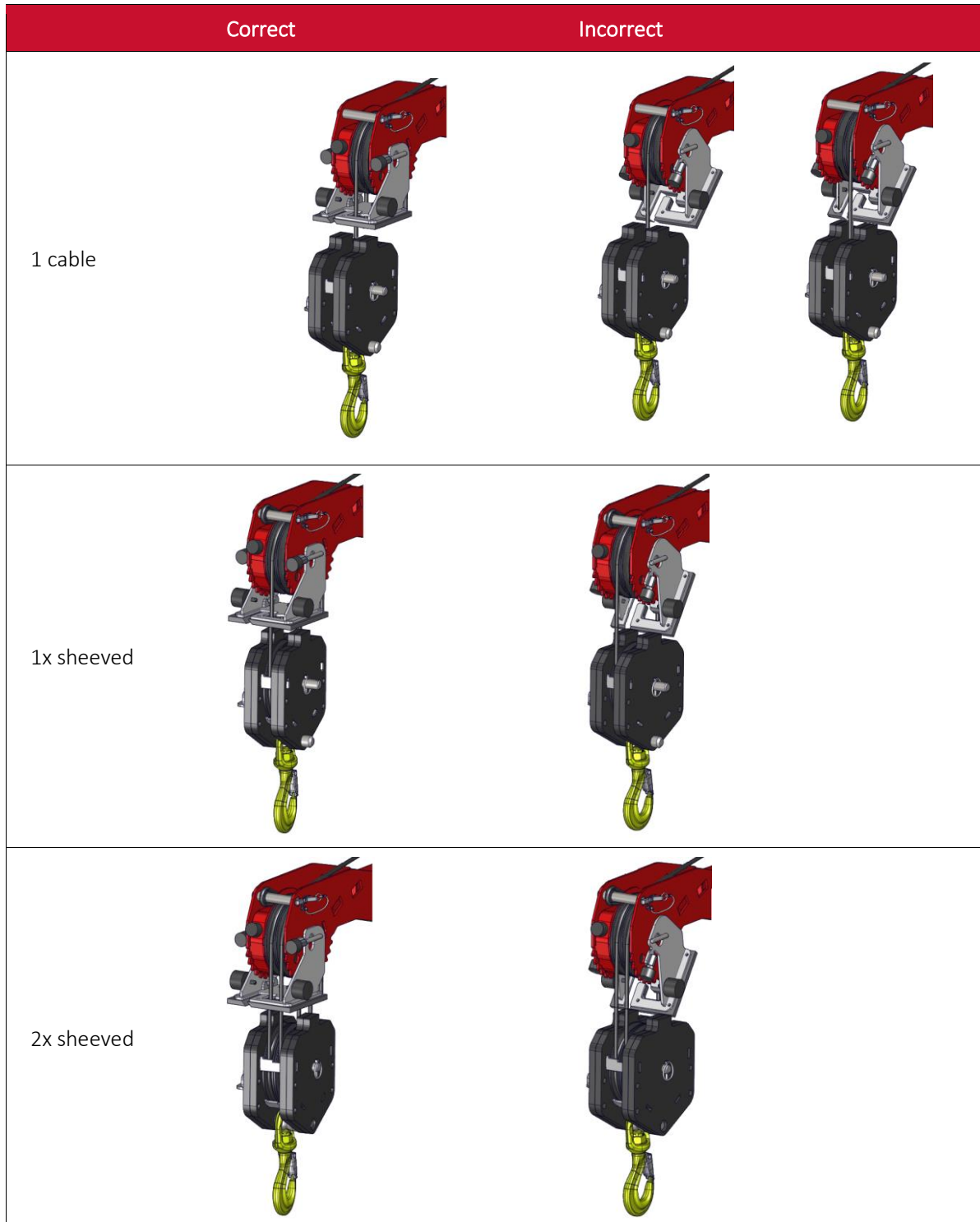

Figure 71

6.7.8 Winch stop

The winch is protected against winching by means of the winch stop. Provided the winch weight is properly mounted on the winch cable and the winch cable is properly mounted in the winch head, the crane will stop winching if the winch weight touches the winch stop on the winch head. The figures below show how the winch cable must be mounted in the winch head and the winch weight.



6.7.9 Explanation of display during lifting

While working with the crane, if the crane is set to crane operation, the following information is shown on the remote control display. The values that appear on the display are explained below.

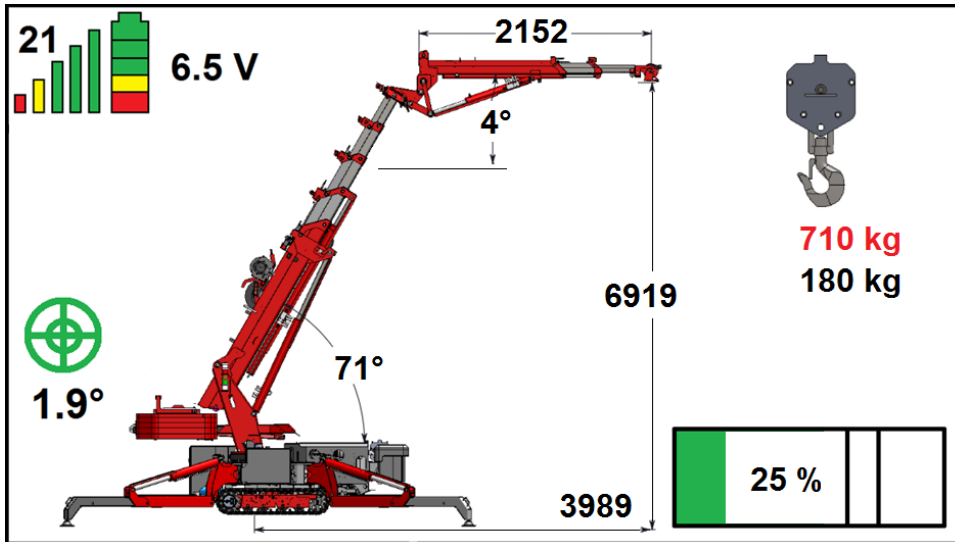

Figure 72



- The transmission frequency is shown at the top left (see figure 72); here it is set to 21.
- The signal strength is indicated by 5 vertical bars. If the strength is good, they are all shown, as in figure 72. As the signal weakens, the green bars disappear first, then the yellow and red ones.
- The battery state of charge is shown in the battery symbol in the top-left corner of the screen. When the battery is fully charged, 3 green blocks, 1 yellow and 1 red are shown, as in figure 72. As the battery discharges, the blocks go out, one at a time.
- The voltage is shown in volts. In figure 72 this is 6.5V.
- The degree of levelling of the machine is also shown. This is indicated by the green circles in the middle. In figure 72 the crane is 1.9° out of level.
- The position of the main mast is 71° in figure 72.
- The position of the jib is 4° in figure 72.
- The radius of the outreach is 3989 mm in figure 72.
- The lifting height is 6919 mm in figure 72.
- The length of the jib is 2152 mm in figure 72.
- The crane can lift 710 kg in this position.
- There is 180 kg in the lifting hook.
- The crane is loaded at 25% in figure 72.
- As can be seen in figure 72, the ballast is extended. If the ballast is retracted, the indicator moves, and if the ballast is removed from the crane, it is no longer shown on the display.

6.7.10 Extending/retracting ballast





LEVENSGEVAAR!

Stay away from the ballast, particularly during retraction of the ballast (risk of crushing).

- If the crane is raised on the outriggers and is set to crane operation, the ballast can be extended.
- Press the  button on the transmitter (*figure 12*) to extend the ballast.
- Slide the ballast all the way out (if the ballast is not extended all the way, the crane will operate as if the ballast were completely retracted!).
- Press the  button on the transmitter (*figure 12*) to extend the ballast.
- The picture on the transmitter display also shows whether the ballast is retracted or extended.

6.8 Pick and carry

If your C6 compact crane has the pick-and-carry option, it is fitted with wider crawler tracks. It is also possible to lift without setting the outriggers. However, the amount of weight that can be lifted is then much less than if the compact crane were standing on the outriggers.

- With the pick-and-carry option it is also possible to switch between the crane operation and driving functions from the remote control (*see figure 12, button* ). Normally this must be done with the key switch (*figure 23*).
- To be able to lift, the tracks must be fully extended. When the tracks are extended, a green dot appears next to each track to indicate that it is fully extended (*see figure 73*).
- If an attempt is made to lift a load that is too heavy for the pick-and-carry mode while this mode is active, the compact crane will not lift it. The compact crane will be capable of lifting at its maximum capacity again once it is raised on the outriggers.
- It is also possible to drive faster by activating the 3rd driving speed on the remote control (*see figure 12, button* ).

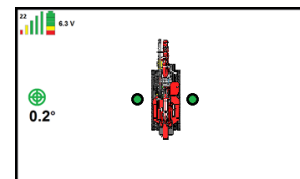









Figure 73

7

MAINTENANCE / TROUBLESHOOTING

7.1 General

	LEVENSGEVAAR!	Remove the key from the key switch before performing work on the compact crane.
	LEVENSGEVAAR!	Never use your hand to locate a leak in the hydraulic system; use a piece of paper or cardboard instead. Oil under high pressure can penetrate the skin and cause poisoning.
	LEVENSGEVAAR!	When topping up the oil, always switch off the crane and press the emergency stop on the remote control.
	LEVENSGEVAAR!	Always correctly reinstall any protection measures that have been removed!
	WAARSCHUWING!	Only the dealer or Hoeflon International may perform work on the electrical or hydraulic system of the machine.
	WAARSCHUWING!	Attention! The parts of the electric motor and motor controllers can still be hot. Let them cool down first!
	VOORZICHTIG!	Consult your dealer

The maintenance instructions are presented in this chapter. Proper maintenance is the key to keeping the machine operating properly. It is very important that these instructions are followed, to ensure your safety and that of others who are present.

Unusual noises or vibrations can indicate a defect in the machine. It is then necessary to perform a repair or maintenance without delay. Consult your dealer about this.

Contact your dealer's technical department for additional information concerning aspects such as maintenance and repair of specific machine parts.

7.2 Maintenance work

The risk of accidents with machines is generally greater during maintenance, cleaning and service. Have your dealer perform the maintenance work on the compact crane. In the Netherlands you can choose to enter a maintenance contract with Hoeflon International B.V. The maintenance intervals and work required are shown in the lubrication chart and maintenance schedule.

Weekly maintenance

- See maintenance chart.
- Grease the compact crane in accordance with the lubrication chart.
- Clean the compact crane with water and a mild cleanser such as car wash shampoo. Never use solvents or other flammable liquids as a cleanser. Never direct the nozzle of a pressure washer directly at the motor or electrical parts.
- Clean the machine daily after use in or transport through a salty/briny environment. Be sure to remove all the salt/brine, to prevent corrosion of the machine.

Monthly maintenance

- See maintenance chart.
- Grease the compact crane in accordance with the lubrication chart.

Scheduled service

- The first scheduled service must be performed after 2 weeks or 50 hours of operation.
- Thereafter the compact crane requires scheduled service annually or every 250 hours of operation.
- It must also be inspected annually.
- It is recommended that you have the scheduled service and inspections performed by your dealer or Hoeflon International B.V.

First use

- Perform the daily inspection (see section 6.1).
- Test the following aspects of the compact crane:
 - Operation of emergency stop.
 - All functions work properly.
 - Safety provisions work properly.

7.3 Maintenance schedule

Description of maintenance	Action	Interval in hours (o = manufacturer/dealer, ● = owner)									
		Daily	First 50	50	100	250	500	1000	4000		
Crawler track undercarriage											
Tension of crawler tracks	Check/adjust			●							
Oil level track motors	Check/top up					o					
	Replace						o				
General											
Machine	Clean			●							
Safety devices	Check	●									
Lifting accessories (cables, hooks etc.)	Check/replace	●									
Control levers	Check	●									
Condition and presence of pictograms	Check					o					
Mechanical components	Check	●									
Boom clearance	Check/adjust							o			
Turntable	Check/tighten		o					o			
	Lubricate			●							
Construction incl. pins, shafts etc.	Check					o					
Boom extension and retraction chains	Check				●						
	Lubricate				●						
Plastic slide plates on boom	Check					o					
	Lubricate			●							
Boom guide bolts	Check					o					
Pivot points and extendable sections	Lubricate			●							
Bolt connections	Tighten						o				
Boom wear parts (completely disassemble)	Replace								o		

Hydraulic system			
Hydraulic oil	Check	●	
	Replace		○
Leaks	Check	●	
	Replace		○
Hydraulic hoses	Check		○
	Replace		○
Pressure levels	Check		○
Hydraulic return filter	Replace	○	○
Hydraulic pressure filter	Replace		○
Stop valves and pressure relief valve	Test		○
Hydraulic system	Rinse		○
Electrical system			
Wiring connectors	Check		○
Emergency stop and sensors	Check	●	
Voltage	Check		○

7.4 Lubrication chart

Lubricate the compact crane as shown in the lubrication chart below, paying particular attention to the following:

- Clean the grease nipples thoroughly before lubrication.
- Remove excess/old grease from the masts.
- Use clean greases, stored in sealed packaging.
- Lubricate the top side of the plastic guide on the boom by inserting a grease gun fitted with a nipple connector through the holes, when the boom is fully extended.

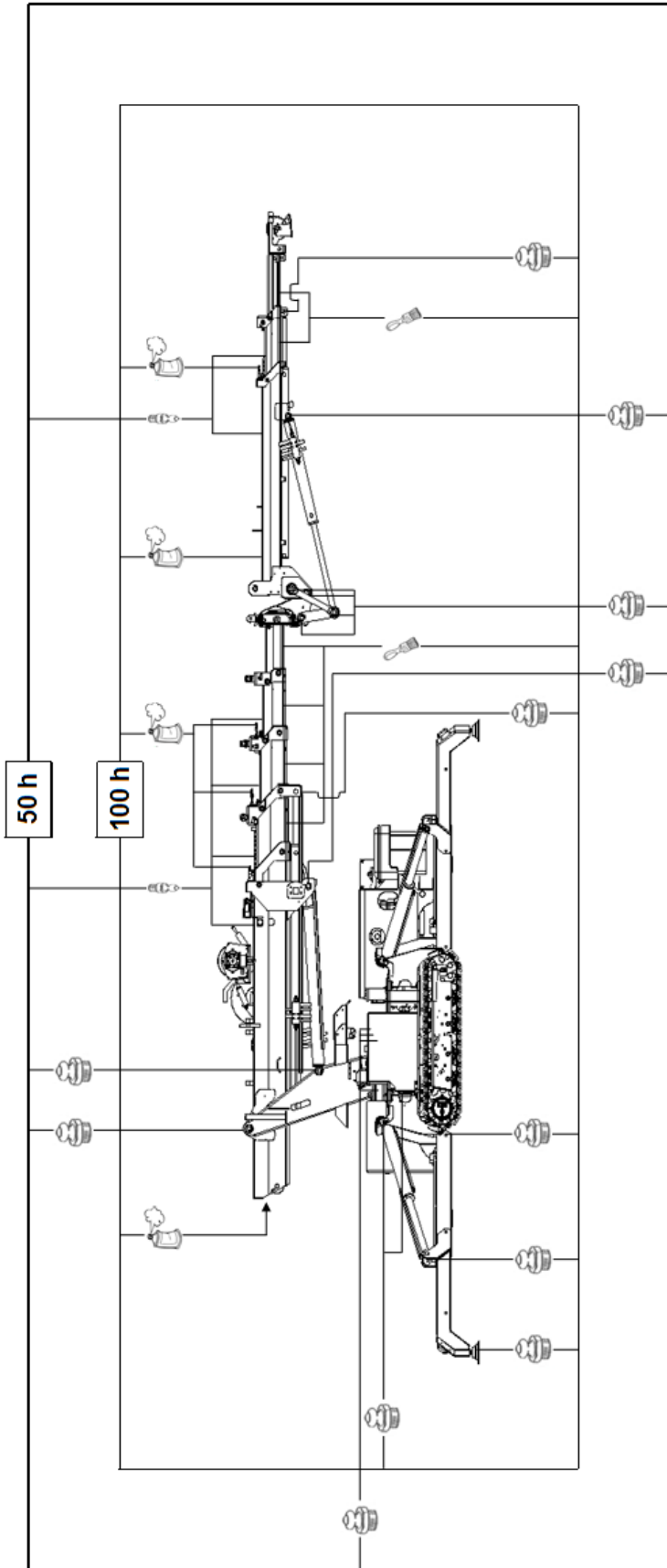

7.5 Lubricant specifications

Manufacturer	Hydraulic oil		Final drives	Lubrication points	Chains	Sliding parts	
	Universal	Organic				Lubricating grease	Spray
Q8	Heller 32	Q8 Holbein HP SE Bio 46	T 55	EP 2	Industrial chain spray	EP2	PTFE
Total	Equavis AF 32 / ZS 46	BioHydran TMP 32	EP-B 80W90	EP 2	Industrial chain spray	EP2	PTFE
Shell	Shell Tellus S2/S3	Shell Naturelle HF-E 32	Spirax S3 AX 80W-90	EP 2	Industrial chain spray	EP2	PTFE
Kroon oil	Perlus ZF 46	Perlus Biosynth 46	Gearlube GL-5 80W-90	EP 2	Industrial chain spray	EP2	PTFE

7.5.1 Boom extension and retraction chains

- Do not repair chains or insert links; if deficient, completely replace.
- If there are two extension or retraction chains, replace both, along with the connections, at the same time.
- If the chains are soiled to the point that lubrication no longer helps, clean with petroleum ether or diesel. Do not clean with acidic agents or a high pressure hose. These can damage the chains.
- Check the chain regularly for lubrication, rust, breaks in the pins/plates and wear and tear.
- Lubricate the chain every 100 hours (see maintenance schedule).

7.6 Use of start assistance terminals

7.6.1 Preparation

- Obtain a start assistance source with the correct voltage and sufficient capacity that is fit for purpose and place it as close as possible to the machine, yet at a safe distance.
- Obtain suitable start assistance cables with sufficient length and thickness and intact insulation, fitted with good, preferably insulated clamps.
- Make sure the area is safe, without any water or conductive materials. Make sure there are no loose parts on the machine or that may fall on the machine.
- Place insulating material to prevent indirect contact with the + terminal (behind red protective cap) and chassis.
- Remove the remote control battery from the charger on the machine to prevent damage.

7.6.2 Procedure

- Make sure the machine is switched off.
- It is a 24V system, so use a 24V charger or vehicle.
- Place insulating material between the chassis and + start assistance terminal, if necessary.
- Make sure the start assistance cables are connected to the start assistance source correctly.
- Always hold the + start assistance cable in your hand, prevent contact and do not place it near the – start assistance cable clamp.
- Prevent the start assistance cables from becoming twisted together; separate them from each other.
- First connect the + start assistance cable by clamping it firmly to the + start assistance terminal (with the red protective cap). Ensure that the clamp cannot contact the chassis or the – start assistance terminal (see figure 74).
- Connect the – start assistance cable.
- Verify that the clamps are correctly attached and making good contact.
- Turn on the key switch on the machine, activate the control and, preferably, switch on an electrical consumer, such as the work light.
- Allow the machine to recharge for a few minutes.
- Switch on the crane so it is in operation.
- Switch off the start assistance source and remove the start assistance cables in the reverse order.
- Place the protective caps back on the start assistance terminals. Replace them if they are damaged.



Figure 74

7.7 Removing/installing ballast

	WAARSCHUWING!	Removal support is only intended for removal of the ballast. For horizontal transport of the ballast, use 2-way chain sling and attach to outrigger plate holders on top of ballast.
	WAARSCHUWING!	Stow removable support after mounting ballast; otherwise support will contact column during retraction.
	WAARSCHUWING!	Never stand within the slewing range of the ballast. During extension, never stand within sliding range of the ballast (risk of crushing).
	WAARSCHUWING!	Be careful not to damage the machine while removing the ballast.

7.7.1 Removing with your own equipment

Preparation

- Make sure the machine is supported on the outriggers in a square configuration, with the tracks just above the ground and no load on the hook.
- Make sure there is enough room for the extended boom on one side, preferably the right side, so the ballast is removed on the left side (because the sensors are on the right side).
- Make sure the tracks are retracted.
- Make sure the boom is horizontal.
- Make sure the ballast is placed in a safe spot, not on walking or driving paths and not within the working range of the compact crane, other machines or workers.

Execution

- Set the boom crosswise on the machine with the ballast on the left side of the machine (see figure 75).



Figure 75

- Slide ballast out (*see figure 76*).



Figure 76

- Take the ballast support out of the storage position and mount and secure it in the ballast removal position (*see figure 77*).



Figure 77

- Remove the rear cover of the boom with a 10 mm Allen key (*see figure 78*).



Figure 78

- Slide the boom out slightly and switch the control off (*see figure 79*).



Figure 79

- Attach the ballast removal cable (*see figure 80*) to the back of the outermost sliding boom section with a bow shackle (*see figure 81*).



Figure 80



Figure 81

- Attach the other end of the ballast removal cable to the ballast removal support with the locking pin (see figure 82). Make sure the cable is not twisted and does not have any loops/windings.



Figure 82

- Switch on the control and slide the boom out until tension is just applied to the ballast cable. Make sure the ballast cable is routed correctly over the cable sheave (see figure 83). Also be careful that the front of the boom does not contact anything (see figure 84).



Figure 83



Figure 84

- Take off the ballast retainer by removing the two hex head bolts with a 24 mm spanner (see figure 85). Remove the silver coloured plate that was held by the bolts.



Figure 85

- Slide the boom out slightly until the ballast is completely supported by the cable (see figure 86).



Figure 86

- Slide the ballast frame completely in; the ballast is now hanging free (see figure 87).



Figure 87

- Turn the ballast a quarter turn and lower the ballast by sliding the boom in slightly; make sure the ballast does not come into contact with the machine or the outriggers (*see figure 89*). Make sure the bow shackle on the ballast cable in the rear of the boom does not go over the cable sheave (*see figure 90*).



Figure 88



Figure 89

- Take off the ballast removal cable and fit the rear boom cover (*see figure 91*).
- Store the ballast retainer with the corresponding bolts and the ballast removal cable with bow shackle and the tools in a safe place, such as the toolbox on the machine.
- The machine can now be positioned in the transport mode and driven off of the ballast.



Figure 90

Check

- Check whether the ballast has disappeared from the display on the remote control.
- Check whether the ballast is in a safe position, move if necessary and/or cordon off the area around the ballast to prevent accidents.

7.7.2 Removing with external equipment

Preparation

- Arrange for a lifting device with sufficient capacity and the appropriate lifting accessories.
- Make sure the machine is supported on the outriggers in a square configuration, with the tracks just above the ground and no load on the hook.
- Make sure the boom is horizontal or in the transport position.

Execution

- Slide the ballast out and switch off the control for the crane.
- Position the lifting device under or attach it to the ballast and allow it to bear part of the weight of the ballast. The ballast removal support is not suitable for horizontal transport of the ballast; use a two-way chain sling that can be hooked directly to the outrigger plate holders on top of ballast.
- Take off the ballast retainer by removing the two hex head bolts with a 24 mm spanner.
- Lift with the lifting device until it is supporting the entire ballast weight.
- Switch on the control for the crane and slide the ballast frame in.
- Remove the ballast with the lifting device and put it in a safe place.
- Store the ballast retainer with the corresponding bolts in a safe place, such as the toolbox.

Check

- Check whether the ballast has disappeared from the display on the remote control.
- Check whether the ballast is in a safe position and cordon off the area around the ballast to prevent accidents.

7.7.3 Fitting ballast with your own equipment

Preparation

- Position the machine with retracted tracks as close as possible to the ballast so the ballast is located with the ballast support on the left side, beside the turntable of the machine.
- Make sure the machine is supported on the outriggers in a square configuration, with the tracks just above the ground and no load on the hook.
- Make sure the boom is horizontal.







Execution

- Set the boom crosswise on the machine with the ballast on the left side of the machine.
- Take the ballast support out of the storage position and mount and secure it in the ballast removal position.
- Remove the rear cover of the boom with a 10 mm spanner.
- Slide the boom out slightly and switch the control off.
- Attach the ballast removal cable to the back of the outermost sliding boom section with a bow shackle. Attach the other end of the ballast removal cable to the ballast removal support with the locking pin. Make sure the cable is not twisted and does not have any loops/windings.
- Switch the control on and slide the boom out until the ballast is at the correct height to slide the ballast support beneath it. Make sure the ballast cable is guided over the cable sheave correctly. During extension, pay attention to the front of the boom too.
- Rotate the ballast a quarter turn.
- Slide out the ballast frame and position the ballast on the ballast frame, then lower the ballast while keeping the cable under tension. Make sure the ballast is straight, to prevent damage to the sensors.
- Fit the ballast retainer and tighten the two bolts with a 24 mm spanner.
- Check whether the ballast appears on the display of the remote control. If not, check whether the ballast is positioned parallel to the ballast frame. Reposition if necessary.
- Release tension on the ballast removal cable by sliding the boom in. Make sure the bow shackle on the ballast cable does not go over the cable sheave.
- Disconnect the ballast removal cable and fit the rear cover of the boom.
- Take the ballast removal support out of the ballast and mount and secure it in the storage position.
- The machine can now be transported in the transport position.

Check

- Check whether the ballast appears on the display, both in the extended and retracted positions.
- Check that the loose parts have been put away or are attached.

7.8 Troubleshooting

	LEVENSGEVAAR!	Remove the key from the key switch when performing work on the compact crane.
	LEVENSGEVAAR!	Never use your hand to locate a leak in the hydraulic system; use a piece of paper or cardboard instead. Oil under high pressure can penetrate the skin and cause poisoning.
	LEVENSGEVAAR!	High voltage! (Danger of electrocution) It is prohibited to remove the rear cover and front covers of the undercarriage. Behind them are battery packs, cables and components that operate at high voltage. This may only be done by technicians specially trained by Hoeflon.
	WAARSCHUWING!	Hydraulic oil can be hot; wear gloves and safety glasses when troubleshooting the hydraulic system.
	WAARSCHUWING!	When a leak has developed in the hydraulic system, not only repair the leak immediately but also top up the oil reservoir.
	WAARSCHUWING!	When disconnecting hydraulic lines and hoses, precautionary measures must be taken to ensure that the line/hose is no longer under pressure once the supply of energy to the system has been switched off. This can be achieved by moving the control levers back and forth.
	VOORZICHTIG!	Consult the dealer

Correct operation and careful maintenance ensure that the compact crane will have a long life with fewer problems.

The warnings above must be heeded for all work performed in connection with a malfunction.

A number of possible malfunctions are shown hereafter. If a malfunction occurs that is not listed in this user manual, contact your dealer or Hoeflon International B.V.

Malfunction	Cause	Solution
The compact crane does not function properly, jerks	Too little oil in the hydraulic system Hesitation when operating lever on remote control.	Check the hydraulic oil level.
Vibrations in the crane	Oil temperature too low	Increase oil temperature by raising and lowering an outrigger leg
Telescopic section does not extend or retract fully or does not do so easily	Guides not sufficiently lubricated	Lubricate the guides
The crane does not slew well	Turntable not sufficiently lubricated Damaged or worn rotation mechanism	Lubricate the turntable Overhaul the turntable mechanism
A number of functions do not work	Problem in electrical system Malfunction of load moment limiter	Check sensors Check emergency stop button Reduce the load on the crane
Winch cable pulling force is incorrect	Leaking winch cylinder	Repair leak
A function does not work	Problem in electrical system, electrical motor has stopped working	Check fuses or emergency stops Fuses in the HV box may only be replaced by Hoeflon.
Movements are slower than usual	Oil filter restricted Hydraulic pump defective	Clean oil filter Replace hydraulic pump
Crunching sound during movements	Pivot points not sufficiently lubricated	Lubricate pivot points in accordance with the lubrication chart

7.8.1 Fault codes

Fault code	Problem	Possible solution. If this does not work, contact Hoeflon.
E001	Problem in software	Contact Hoeflon
E002	Problem in software	Contact Hoeflon
E003	Problem in software	Contact Hoeflon
E004	Problem in software	Contact Hoeflon
E005	Problem in software	Contact Hoeflon
E006	Problem in software	Contact Hoeflon
E007	Problem in software	Contact Hoeflon
E008	Problem in software	Contact Hoeflon
E009	Problem in software	Contact Hoeflon
E010	Problem in software	Contact Hoeflon
E011	Not used	
E012	Not used	
E013	Not used	
E014	Not used	
E015	Not used	
E016	Not used	
E017	Not used	
E018	Not used	
E019	Not used	
E020	Not used	
E021	Not used	
E022	Not used	
E023	Not used	
E024	Not used	
E025	Not used	
E026	Not used	
E027	Not used	
E028	Crane is not supported properly by outriggers	Set outriggers again

E029	Not used	
E030	Not used	
E031	Not used	
E032	Not used	
E033	Not used	
E034	Not used	
E035	Not used	
E036	Not used	
E037	Not used	
E038	Not used	
E039	Not used	
E040	Not used	
E041	Not used	
E042	Not used	
E043	Not used	
E044	Not used	
E045	Not used	
E046	Not used	
E047	Not used	
E048	Not used	
E049	Not used	
E050	Not used	
E051	Not used	
E052	Not used	
E053	Not used	
E054	Not used	
E055	Not used	
E056	Not used	
E057	Not used	
E058	Not used	
E059	Problem with connection	Contact Hoeflon or your dealer

E060	Problem with connection	Contact Hoeflon or your dealer
E061	Problem with connection	Contact Hoeflon or your dealer
E062	Not used	
Fault code	Problem	Possible solution. If this does not work, contact Hoeflon.
E063	Not used	
E064	Not used	
E065	Not used	
E066	Problem with connection	Switch machine off and on again.
E067	Problem with connection	Switch machine off and on again.
E068	Not used	
E069	Not used	
E070	Problem with connection	Switch machine off and on again.
E071	Problem with connection	Switch machine off and on again.
E072	Not used	
E073	Not used	
E074	Problem with connection	Switch machine off and on again.
E075	Problem with connection	Switch machine off and on again.
E076	Not used	
E077	Not used	
E078	No contact with left-front angle sensor	Switch machine off and on again.
E079	Incorrect value left-front angle sensor	Switch machine off and on again.
E080	Incorrect value left-front angle sensor	Switch machine off and on again.
E081	Problem left front	Contact Hoeflon or your dealer.
E082	Problem left-front length sensor	Activate the bypass and extend farther. The fault code disappears. Switch the bypass off.
E083	Problem left-front length sensor	Activate the bypass and extend farther. The fault code disappears. Switch the bypass off.
E084	Not used	
E085	No contact with right-front angle sensor	Switch machine off and on again.

E086	Incorrect value right-front angle sensor	Switch machine off and on again.
E087	Incorrect value right-front angle sensor	Switch machine off and on again.
E088	Problem right front	Contact Hoeflon or your dealer.
E089	Problem right-front length sensor	Activate the bypass and extend farther. The fault code disappears. Switch the bypass off.
E090	Problem right-front length sensor	Activate the bypass and extend farther. The fault code disappears. Switch the bypass off.
E091	Not used	
E092	No contact with right-rear angle sensor	Switch machine off and on again.
E093	Incorrect value right-rear angle sensor.	Switch machine off and on again.
E094	Incorrect value right-rear angle sensor.	Switch machine off and on again.
E095	Problem right front	Contact Hoeflon or your dealer.
E096	Problem right-rear length sensor	Activate the bypass and extend farther. The fault code disappears. Switch the bypass off.
E097	Problem right-rear length sensor	Activate the bypass and extend farther. The fault code disappears. Switch the bypass off.
E098	Not used	
E099	No contact with left-rear angle sensor	Switch machine off and on again.
E100	Incorrect value left-rear angle sensor	Switch machine off and on again.
E101	Incorrect value left-rear angle sensor	Switch machine off and on again.
E102	Problem right front	Contact Hoeflon or your dealer.
E103	Problem left-rear length sensor	Activate the bypass and extend farther. The fault code disappears. Switch the bypass off.
E104	Problem left-rear length sensor	Activate the bypass and extend farther. The fault code disappears. Switch the bypass off.
E105	Not used	
E106	No contact with jib angle sensor	Switch machine off and on again.
E107	Incorrect value jib angle sensor	Switch machine off and on again.

E108	Incorrect value jib length sensor	Activate the bypass and extend farther. The fault code disappears. Switch the bypass off.
E109	Not used	
E110	No contact with boom angle sensor	Switch machine off and on again.
E111	Incorrect value boom angle sensor	Switch machine off and on again.
E112	Not used	
E113	No contact with pressure sensor boom lift cylinder	Switch machine off and on again.
E114	No contact with pressure sensor boom lift cylinder	Switch machine off and on again.
E115	Not used	
Fault code	Problem	Possible solution. If this does not work, contact Hoeflon.
E116	No contact with bin angle sensor	Switch machine off and on again.
E117	Incorrect value bin angle sensor	Switch machine off and on again.
E118	Incorrect value bin dummy sensor	Check whether dummy plug is connected correctly
E119	Not used	
E120	No contact with boom rotation sensor	Switch machine off and on again.
E121	Incorrect value boom rotation sensor	Switch machine off and on again.
E122	Incorrect value boom rotation sensor	Switch machine off and on again.
E123	Not used	
E124	Low oil pressure in Yanmar engine	Check engine oil level
E125	Motor temperature too high	Check coolant level
E126	Alternator not charging	Check alternator
E127	Not used	
E128	Not used	
E129	Not used	
E130	Not used	
E131	Ballast is crooked	Slide ballast in and out



E132	Ballast is crooked	Slide ballast in and out
E133	Ballast is crooked	Slide ballast in and out
E134	Not used	
E135	Oil pressure winch sensor out of range	Contact Hoeflon or your dealer
E136	No contact with pressure sensor	Switch machine off and on again.
E137	Incorrect value pressure sensor	Switch machine off and on again.
E138	Pressure too high	Wind out winch cable, reduce lifting weight
E139	Problem in winch switch	Winch cable can only be wound out
E140	Problem in winch switch	Winch cable can only be wound up
E141	Not used	
E142	Not used	
E143	Not used	
E144	Not used	
E145	Not used	
E146	Not used	
E147	Not used	
E148	No contact with level sensor	Switch machine off and on again.
E149	Invalid value level sensor	Switch machine off and on again.
E150	Not used	
E151	Not used	
E142	Maintenance (minor service)	Contact Hoeflon or your dealer
E153	Maintenance (major service)	Contact Hoeflon or your dealer
E154	Maintenance	Contact Hoeflon or your dealer

8

TRANSPORT, STORAGE, DISPOSAL

8.1 Transport

8.1.1 General

	WAARSCHUWING!	Only use suitable lifting accessories with the correct capacity for the lifting application. The lifting accessories must be accompanied by a certificate, have a periodic inspection, be visually inspected and have been found to be suitable for use.
	WAARSCHUWING!	The clearance angle of the loading ramps must not exceed 15 degrees.
	WAARSCHUWING!	When transporting the compact crane, make sure the crane is in transport mode and that any load is removed: no load on the hook, outriggers stowed in transport position and boom retracted.

- Make sure the outriggers are fully retracted and locked in position and that the crane is fully collapsed.
- There must not be any load on the compact crane.
- Use loading ramps of sufficient size and capacity. The loading ramps must be long enough so that the angle with the ground is less than 15°.
- Drive the machine forwards onto a means of transport intended for this purpose in the way described in section 6.4; when driving the machine up the ramps the operator must be assisted by a person who provides instructions concerning the driving direction.
- Stop the motor as described in section 6.4.

- Set the switch on the electrical cabinet to position '0'.
- Remove any loose parts from the machine.
- Secure the machine by attaching four lashing straps to the holes in the outrigger leg hinge plates. The machine can also be secured by attachment to the crane column (see figures 92, 93, 94 and 95).



Figure 93



Figure 91



Figure 94



Figure 95

- Make sure that the outriggers are fully retracted and locked in position and that the crane is fully collapsed.
- There must not be any load on the compact crane.
- Lift the compact crane using lifting straps or chain slings with a capacity of at least 3000 kg. Fasten these to the lifting point on the boom (see figure 96).



Figure 96

8.1.2 Securing

	WAARSCHUWING!	Overloaded eyes can cause damage to the machine. Therefore always heed the following instructions.
	WAARSCHUWING!	Folding a lashing strap double also doubles the applied tension.

Point	Load on attachment point
Lashing points on undercarriage	Max 2500 kg per eye
Lashing points on superstructure	Front max. 1500 kg per eye
	Rear max. 2500 kg per eye

- Towards the front and sides, lash down at least 0.5x the machine's weight; towards the rear lash down at least 1x the machine's weight.
- It is recommended that the space between the headboard of the transport vehicle and the front of both tracks be filled, in connection with braking forces. Otherwise, use lashing provisions that can hold at least 1.5x the machine's weight at the rear.
- If the lashing eyes on the undercarriage are used to secure the crane, the superstructure must be secured to prevent rotation in both directions. Otherwise the turntable may be damaged by movement that occurs during transport.
- Make sure the tracks of the compact crane are resting directly on the deck of the transport vehicle, because ground protection plates or anything similar in between will reduce the sliding resistance of the crane relative to the transport vehicle.

8.2 Storage

Perform the following procedure before storing the compact crane for longer than 3 months:

- Remove any dirt and clean the machine with water and e.g. car wash shampoo. The crawler track undercarriage may be cleaned with a high pressure jet.
- Grease the compact crane in accordance with the lubrication chart in section 7.4.
- Touch up any damage to the paintwork.
- Oil parts that may rust easily, such as exposed sections of hydraulic piston rods.
- Connect the plug of the EV charging station to the crane so it keeps the battery packs and the 24 V system in good condition.
- Ensure that the compact crane cannot be activated by unauthorised persons.
- Cover the compact crane with tarpaulin; keep a section free from the ground to allow for ventilation.

After the compact crane has been in storage for an extended period (longer than 3 months), follow these instructions:

- Remove the tarpaulin.
- Check the battery voltage at the charging current meter on the side of the machine.
- Perform the daily inspection before use.



VOORZICHTIG!

If the compact crane will be placed in storage for more than six months, contact Hoeflon International B.V. for the procedure to be followed.

8.3 Disposal

Dispose of waste in accordance with the applicable local regulations. Incorrect disposal of waste can be harmful to the environment. Environmentally harmful waste includes: engine oil, diesel fuel, hydraulic oil, differential oil, coolant, filters, batteries and greases.

The OX battery packs must be submitted to Hoeflon.

9

ANNEXES

9.1 Load chart C6E

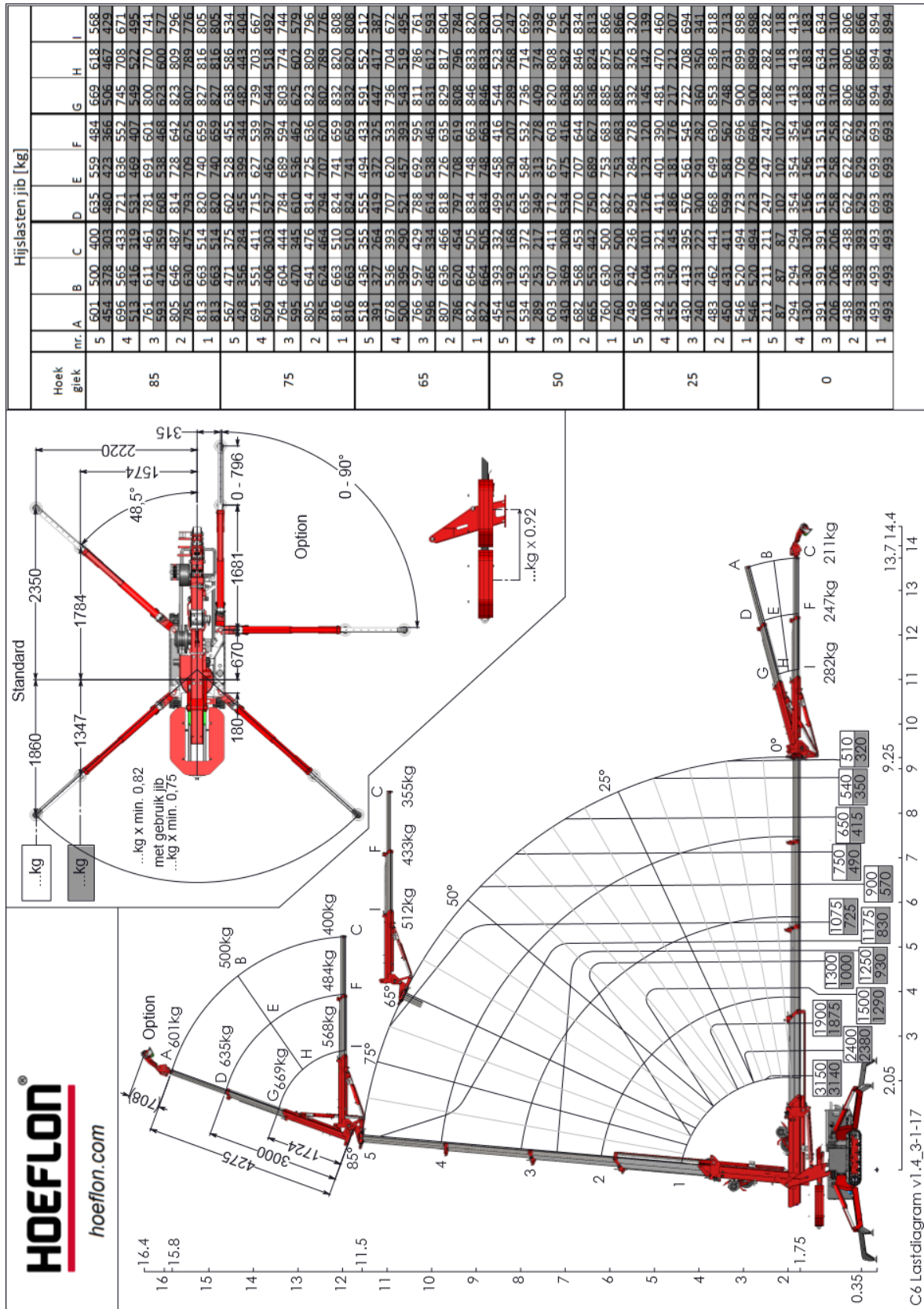

9.2 Outrigger pressure

Maximum outrigger pressure C6

Crane type	C6
Outrigger radius	2400 mm
Outrigger angle	4x 48.5 degrees
Outrigger length	Extended
Ballast weight	Extended
Maximum lifting capacity	3000 kg
Net weight	2850 kg
Maximum outrigger pressure in the most unfavourable position	3300 kg
Minimum outrigger pressure	2150 kg
Maximum outrigger pressure with outriggers in square configuration	2600 kg

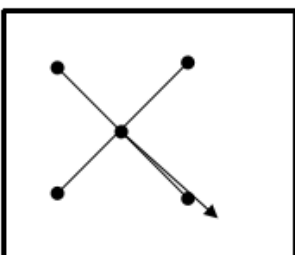
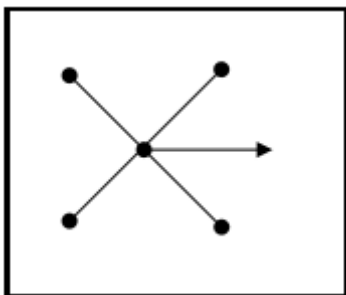
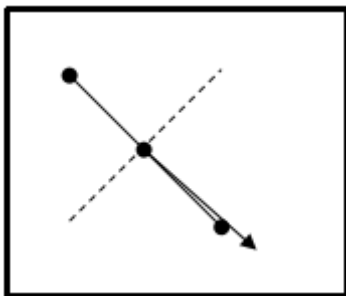

9.3 Annexes

- Crane book